

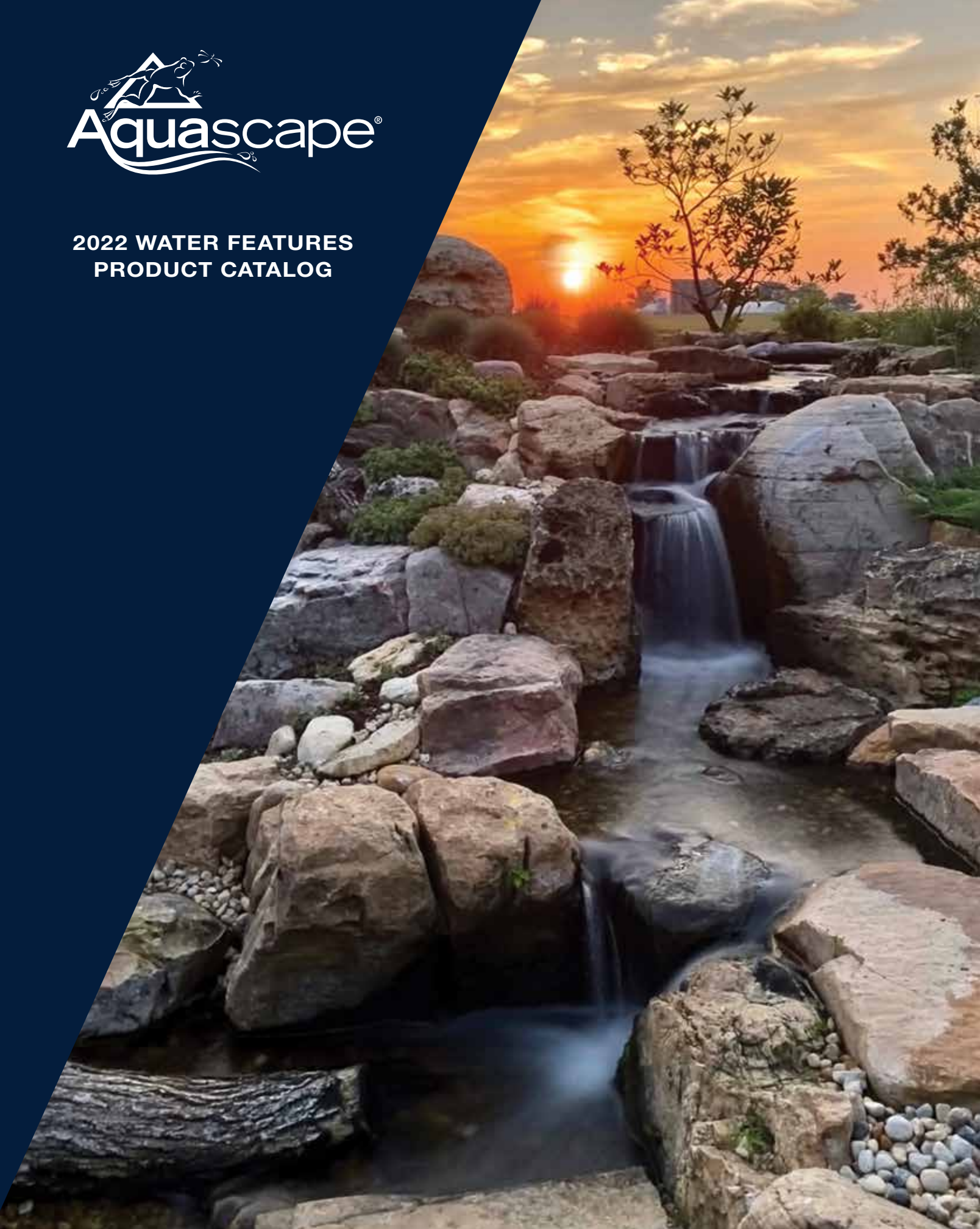

**2022 WATER FEATURES  
PRODUCT CATALOG**



# “I ❤️ MY JOB!”

I've uttered that phrase hundreds, if not thousands, of times on my YouTube channel and across my myriad of social media accounts – but it's pretty easy to say when your profession is also your hobby!

As I look today at how we have evolved our Aquascape product offerings over our 30 years in this industry, I'll admit – I'm a bit jealous. So many state-of-the-art water feature gadgets and devices (that I would have loved in my early years as a hobbyist) exist today solely because of our relentless goal to “improve the consumer's experience with water features.”

Basically, the trials and tribulations we experienced as early pond hobbyists led Aquascape to developing ground-breaking solutions that make the hobby of water gardening more beautiful and more enjoyable than

ever before, while also making ponds, waterfalls, and fountainscapes simple to build and easy to maintain.

From a smartphone app that puts controlling your water feature directly into your hands to fire elements that expand your hours of enjoyment, our product offerings can't be found anywhere else. When you add in breakthrough innovations like the IonGen™ System G2 that controls algae electronically and the Automatic Dosing System that eliminates much of your manual routine maintenance, you can see why I'm so excited about today's technological advances!

Plus, thanks to the prevalence of social media, we now have the opportunity to share our passion for water features with the WORLD and inspire one another to fully enjoy “Living the Aquascape Lifestyle®!”



I invite you to scan the code below and begin enjoying all the ways we connect with fellow water feature owners around the world!

Simply put, "I ♥ MY JOB!" and we at Aquascape are fully dedicated to helping you say "I ♥ MY WATER FEATURE!"

*Greg Wittstock  
The Pond Guy*

Greg Wittstock, The Pond Guy  
Founder and CEO  
Aquascape, Inc.



# Hands of the Artist

When it comes to building work-of-art, one-of-a-kind, custom creations, we don't create with canvas, acrylics, or a paint brush. We use rock, gravel, and water as our media.

Aquascape is pleased to introduce ***Hands of the Artist*** – a full-color, hardcover coffee table book featuring stunning, hand-created Aquascape water features that are brought to you by Aquascape and our talented TRIBE of Certified Aquascape Contractors.

A work of art unto its own, ***Hands of the Artist*** won't disappoint. Page-by-page and build-by-build, you'll be mesmerized by the stunning artistry of our work. ***Hands of the Artist*** will be a treasured and timeless keepsake for you and those who enjoy Living the Aquascape Lifestyle®.

Hands of the Artist  
#86435



 Availability of Hands of the Artist books will be limited, and future print runs are NOT guaranteed!



**At Aquascape, our mission is to connect people to water the way nature intended.** We help people transform their outdoor living space and how they spend their leisure time. Living the Aquascape Lifestyle® is about enjoying your own personal retreat with a beautiful water feature. When you live with a pond, waterfall, or fountain, you are drawn outside, away from daily stresses, to interact with your landscape in a variety of ways. Water feature owners enjoy feeding colorful fish, watching birds splash in a waterfall, or listening to the tranquil sounds of moving water. The benefits are plentiful, and Aquascape makes it easier than ever to enjoy the Aquascape Lifestyle.

# TABLE OF CONTENTS

<b>POND KITS</b>	8
<b>PONDLESS® WATERFALL KITS</b>	13
<b>BACKYARD WATERFALL LANDSCAPE FOUNTAIN KIT</b>	18
<b>LANDSCAPE FOUNTAIN KITS</b>	20
<b>FILTRATION</b>	25
<b>PUMPS</b>	42
<b>AERATION</b>	60
<b>POND AND LANDSCAPE LIGHTING</b>	64
<b>POWER</b>	75
<b>WATER TREATMENTS</b>	78
<b>PREDATOR CONTROL</b>	100
<b>SEASONAL CARE</b>	102
<b>FISH CARE</b>	106
<b>AQUATIC PLANT CARE</b>	112
<b>DECORATIVE</b>	114
<b>LINER, UNDERLAYMENT, AND GEOTEXTILE</b>	136
<b>PIPE AND PLUMBING</b>	139
<b>INSTALLATION TOOLS</b>	143
<b>RAINWATER HARVESTING</b>	146





# How Smart Is Your Pond?

Control, schedule, and monitor your pond, waterfall, or fountain with Aquascape smart control products.



## It's Easy As 1-2-3



- 1. Download** the Aquascape Smart Control App to your smartphone or tablet
- 2. Control** and schedule lights, pumps, fountains, and more
- 3. Monitor** your water temperature, power consumption, and devices, in real-time from anywhere in the world

[AQUASCAPEINC.COM/SMART-CONTROL-APP](http://AQUASCAPEINC.COM/SMART-CONTROL-APP)

### Aquascape Smart Control Products



**Smart Pond Thermometer**  
see page 103



**Smart Control Plug**  
see page 77



**Smart Control Receiver**  
see page 43



**Smart Control Hub**  
see page 66



**Smart Pond Dosing System XT**  
see page 80

# Aquascape Products



## Smart Pond Dosing System XT

Innovative dosing system with app-integration, low-treatment alert, and ability to treat larger water features with ease!

For more information, see page 80.



## Simple Solutions Treatments for XT Dosing System

The same great Simple Solutions treatments in bottles for use with the XT System, including 3X-concentrated treatments for large ponds.

For more information, see page 83.



## EXT Pond Pumps

High-flow, quiet, and reliable external pumps ideal for recirculating water in recreation ponds. The available plumbing kit makes it easy to install, prime, and operate.

For more information, see page 49.



## AquaSurge® and Ultra Re-design

New front cage design for both the AquaSurge® and Ultra pumps makes maintenance easy with a new integrated knob for quick cage removal.

For more information, see page 44 and 56.



## Fire and Water Stacked Slate Urn - Large

Excite your senses with this auto-ignite, fire and water feature for use in a variety of applications.

For more information, see page 116.



## Stainless Steel Fire Pan Cover

Cover fire burners on Aquascape Auto-Ignite Fire Features to protect burner components from the elements, such as snow and rain.

For more information, see page 118.



## AquaGarden Tabletop Fountain Kit

Add a water garden to any indoor location. Great for offices, kitchens, desks, tables, sunrooms, and other indoor locations.

For more information, see page 131.



## Adjustable Flow Pump Extension Cord

Extend your adjustable flow pond pump further from the Smart Control Receiver with this 25 ft. extension cord.

For more information, see page 44, 46, and 52.



## Faux Stump Propane Tank Cover

Conceal standard propane tanks using this lightweight and durable faux stump cover with extremely realistic oak appearance.

For more information, see page 118.



## Round Propane Tank Cover - Gray

Conceal standard propane tanks using this durable, GFRC cover with contemporary, smooth gray design.

For more information, see page 118.



## Square Propane Tank Cover - Travertine

Conceal standard propane tanks using this durable, GFRC cover with elegant travertine finish and texture.

For more information, see page 118.



**Transform your outdoor living space with a beautiful ecosystem pond** that can be created with a convenient kit. The Aquascape approach to creating a backyard pond is to provide a complete, low-maintenance system that works with Mother Nature for a naturally balanced pond with clean, healthy water. Selected pond kit components integrate seamlessly and complement the addition of rocks, gravel, fish, and plants. Aquascape offers a variety of pond kit sizes to suit your space.



## THE ECOSYSTEM POND

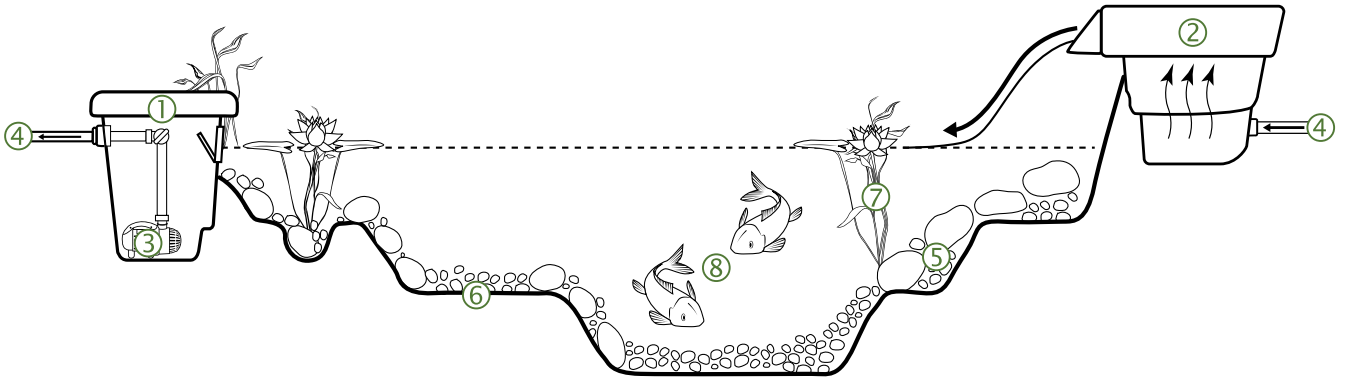

- 1. Pond Skimmer**—Pre-filters water and houses pump, collects debris, and reduces maintenance
- 2. BioFalls® Filter**—Provides surface area for beneficial bacteria to colonize and remove excess nutrients from the water
- 3. Pond Pump**—Pumps water from the pond skimmer to the BioFalls Filter to create a waterfall
- 4. Pipe**—Directs water from the skimmer to the BioFalls Filter
- 5. Rocks and Gravel (not included)**—Protects the liner, naturalizes the pond bottom, and provides surface area for beneficial bacteria to break down excess nutrients
- 6. Pond Liner and Underlayment**—Forms the pond's foundation for containing the water and allowing gases to escape from beneath the pond
- 7. Plants (not included)**—Filter pond water, thereby minimizing maintenance and improving water conditions
- 8. Fish (not included)**—Provide nutrients for pond plants and reduce maintenance

## DIY BACKYARD POND KITS



### DIY Backyard Pond Kit 4' x 6'

#99763

Packaged Weight: 71.5 lb.  
Packaged Dimensions: 34"L x 22"W x 23"H

### DIY Backyard Pond Kit 6' x 8'

#99764

Packaged Weight: 85 lb.  
Packaged Dimensions: 34"L x 22"W x 23"H

### DIY Backyard Pond Kit 8' x 11'

#99765

Packaged Weight: 105 lb.  
Packaged Dimensions: 34"L x 22"W x 23"H

FILTRATION	PUMP	PLUMBING	INSTALLATION KIT
<ul style="list-style-type: none"> <li>Signature Series 200 Pond Skimmer</li> <li>Signature Series 1000 BioFalls® Filter</li> <li>BioBalls Biological Filter Media with media net</li> </ul>	<ul style="list-style-type: none"> <li>EcoWave® 2000 Pond Pump</li> </ul>	<ul style="list-style-type: none"> <li>Kink-Free Pipe—1.5" x 25'</li> <li>Hose Clamps</li> </ul>	<ul style="list-style-type: none"> <li>Black Silicone Sealant—4.7 oz.</li> <li>Pond and Waterfall Foam Sealant</li> </ul>
FINISHED POND SIZE	45 MIL EPDM LINER	UNDERLAYMENT	WELCOME KIT
<ul style="list-style-type: none"> <li>4'W x 6'L x 2'D (#99763)</li> <li>6'W x 8'L x 2'D (#99764)</li> <li>8'W x 11'L x 2'D (#99765)</li> </ul> <p>May vary based on pond shape and rock size</p>	<ul style="list-style-type: none"> <li>8' x 10' (#99763)</li> <li>10' x 12' (#99764)</li> <li>12' x 15' (#99765)</li> </ul>	<ul style="list-style-type: none"> <li>80 sq. ft. (#99763)</li> <li>120 sq. ft. (#99764)</li> <li>180 sq. ft. (#99765)</li> </ul>	<p>Contains a gift for you, a USB with instructions and videos, and a starter water treatment.</p>

## PROFESSIONAL GRADE POND KITS

### Small Pond Kit 8' x 11'

#53033

Packaged Weight: 145 lb.  
Packaged Dimensions: 25"L x 40"W x 30"H



FILTRATION	PUMP	PLUMBING	WATER TREATMENT
<ul style="list-style-type: none"> <li>Signature Series 400 Pond Skimmer</li> <li>Signature Series 1000 BioFalls® Filter</li> <li>BioFalls® rock tray</li> <li>BioBalls Biological Filter Media with media net</li> </ul>	<ul style="list-style-type: none"> <li>AquaSurge® 3000 Pond Pump</li> </ul>	<ul style="list-style-type: none"> <li>Dual Union Check Valve 2.0</li> <li>Flexible PVC Pipe—1.5" x 25'</li> </ul>	<ul style="list-style-type: none"> <li>Automatic Dosing System for Ponds</li> <li>Maintain for Ponds water treatment</li> </ul>
FINISHED POND SIZE	LINER & UNDERLAYMENT	INSTALLATION KIT	WELCOME KIT
<p>8'W x 11'L x 2'D—may vary based on pond shape and rock size</p>	<ul style="list-style-type: none"> <li>45 mil EPDM Liner—12' x 15'</li> <li>Underlayment—180 sq. ft.</li> </ul>	<ul style="list-style-type: none"> <li>Black Silicone Sealant—4.7 oz.</li> <li>EPDM Liner Patch 6"</li> <li>Pond and Waterfall Foam Sealant</li> <li>PVC glue/cement</li> </ul>	<p>Contains a gift for you, a USB with instructions and videos, and a starter water treatment.</p>

## PROFESSIONAL GRADE POND KITS

### Medium Pond Kit 11' x 16'

**#53034**

with AquaSurge® 2000-4000 Adjustable Flow Pond Pump



**#53035**

with 3-PL 3000 Solids-Handling Pond Pump



Packaged Weight: 290 lb.

Packaged Dimensions: 48"L x 40"W x 31"H Palletized

FILTRATION	PUMP & PLUMBING	LED LIGHTING	WATER TREATMENT
<ul style="list-style-type: none"> <li>Signature Series 1000 Pond Skimmer</li> <li>Signature Series 2500 BioFalls® Filter</li> <li>BioFalls® rock tray</li> <li>BioBalls Biological Filter Media with media net</li> <li>BioFalls® Faux Rock Lip</li> </ul>	<ul style="list-style-type: none"> <li>Choice of pump above</li> <li>Dual Union Check Valve 2.0</li> <li>Flexible PVC Pipe—2" x 25'</li> </ul>	<ul style="list-style-type: none"> <li>(2) 3-Watt Spotlight</li> <li>1-Watt Waterfall Light</li> <li>60-Watt Low Voltage Transformer with Photocell</li> <li>3-Way Quick-Connect Splitter</li> <li>25' Quick-Connect Extension Cable</li> </ul>	<ul style="list-style-type: none"> <li>Automatic Dosing System for Ponds</li> <li>Maintain for Ponds water treatment</li> </ul>
FINISHED POND SIZE	LINER & UNDERLAYMENT	INSTALLATION KIT	WELCOME KIT
11'W x 16'L x 2'D—may vary based on pond shape and rock size	<ul style="list-style-type: none"> <li>45 mil EPDM Liner—15' x 20'</li> <li>Underlayment—300 sq. ft.</li> </ul>	<ul style="list-style-type: none"> <li>Black Silicone Sealant—4.7 oz.</li> <li>EPDM Liner Patch 6"</li> <li>Pond and Waterfall Foam Sealant</li> <li>PVC glue/cement</li> </ul>	Contains a gift for you, a USB with instructions and videos, and a starter water treatment.

### Large Pond Kit 21' x 26'

**#53036**

with AquaSurge® 4000-8000 Adjustable Flow Pond Pump



**#53037**

with 9-PL 7000 Solids-Handling Pond Pump

**#53063**

with SLD 5000-9000 Solids-Handling Pond Pump



Packaged Weight: 488 lb.

Packaged Dimensions: 48"L x 40"W x 41"H Palletized

FILTRATION	PUMP & PLUMBING	LED LIGHTING	WATER TREATMENT
<ul style="list-style-type: none"> <li>Signature Series 1000 Pond Skimmer</li> <li>Signature Series 6000 BioFalls® Filter</li> <li>BioFalls® rock tray</li> <li>BioBalls Biological Filter Media with media net</li> </ul>	<ul style="list-style-type: none"> <li>Choice of pump above</li> <li>Dual Union Check Valve 2.0</li> <li>Flexible PVC Pipe—2" x 50'</li> </ul>	<ul style="list-style-type: none"> <li>(2) 3-Watt Spotlight</li> <li>1-Watt Waterfall Light</li> <li>60-Watt Low Voltage Transformer with Photocell</li> <li>3-Way Quick-Connect Splitter</li> <li>25' Quick-Connect Extension Cable</li> </ul>	<ul style="list-style-type: none"> <li>Automatic Dosing System for Ponds</li> <li>Maintain for Ponds water treatment</li> </ul>
FINISHED POND SIZE	LINER & UNDERLAYMENT	INSTALLATION KIT	WELCOME KIT
21'W x 26'L x 2'D—may vary based on pond shape and rock size	<ul style="list-style-type: none"> <li>45 mil EPDM Liner—25' x 30'</li> <li>Underlayment—750 sq. ft.</li> </ul>	<ul style="list-style-type: none"> <li>Black Silicone Sealant—4.7 oz.</li> <li>EPDM Liner Patch 6"</li> <li>Pond and Waterfall Foam Sealant</li> <li>PVC glue/cement</li> </ul>	Contains a gift for you, a USB with instructions and videos, and a starter water treatment.

## DELUXE POND KITS

Aquascape deluxe pond kits include the components found in professional grade pond kits, but are enhanced with the addition of the Pond Powerhead, Faux Driftwood 30", and color-changing light package. Connect the pump and lights to the Smart Control App and control them with your smartphone or tablet.

Deluxe Kits Include  
Smart Control Pump and Lights



### Medium Deluxe Pond Kit 11' x 16'



#53066

Packaged Weight: 315 lb.

Packaged Dimensions: 48"L x 40"W x 31"H Palletized



FILTRATION	PUMP & PLUMBING	COLOR-CHANGING LIGHT KIT	DELUXE ADD ONS
<ul style="list-style-type: none"> <li>Signature Series 1000 Pond Skimmer</li> <li>Signature Series 2500 BioFalls® Filter</li> <li>BioFalls® rock tray</li> <li>BioBalls Biological Filter Media with media net</li> <li>BioFalls® Faux Rock Lip</li> </ul>	<ul style="list-style-type: none"> <li>AquaSurge® 2000-4000 Adjustable Flow Pond Pump</li> <li>Dual Union Check Valve 2.0</li> <li>Flexible PVC Pipe—2" x 25'</li> </ul>	<ul style="list-style-type: none"> <li>Smart Control Hub</li> <li>(2) 4.5-Watt Color-Changing Spotlight</li> <li>2-Watt Color-Changing Waterfall Light</li> <li>150-Watt Low Voltage Transformer with Photocell</li> <li>3-Way Color-Changing Splitter</li> <li>25' Color-Changing Extension Cable</li> </ul>	<ul style="list-style-type: none"> <li>Automatic Dosing System for Ponds</li> <li>Maintain for Ponds water treatment</li> <li>Pond Powerhead</li> <li>Faux Driftwood 30"</li> </ul>
FINISHED POND SIZE	LINER & UNDERLAYMENT	INSTALLATION KIT	WELCOME KIT
11'W x 16'L x 2'D—may vary based on pond shape and rock size	<ul style="list-style-type: none"> <li>45 mil EPDM Liner—15' x 20'</li> <li>Underlayment—300 sq. ft.</li> </ul>	<ul style="list-style-type: none"> <li>Black Silicone Sealant—4.7 oz.</li> <li>EPDM Liner Patch 6"</li> <li>Pond and Waterfall Foam Sealant</li> <li>PVC glue/cement</li> </ul>	Contains a gift for you, a USB with instructions and videos, and a starter water treatment.

### Large Deluxe Pond Kit 21' x 26'



#53067

Packaged Weight: 513 lb.

Packaged Dimensions: 48"L x 40"W x 41"H Palletized



FILTRATION	PUMP & PLUMBING	COLOR-CHANGING LIGHT KIT	DELUXE ADD ONS
<ul style="list-style-type: none"> <li>Signature Series 1000 Pond Skimmer</li> <li>Signature Series 6000 BioFalls® Filter</li> <li>BioFalls® rock tray</li> <li>BioBalls Biological Filter Media with media net</li> </ul>	<ul style="list-style-type: none"> <li>AquaSurge® 4000-8000 Adjustable Flow Pond Pump</li> <li>Dual Union Check Valve 2.0</li> <li>Flexible PVC Pipe—2" x 50'</li> </ul>	<ul style="list-style-type: none"> <li>Smart Control Hub</li> <li>(2) 4.5-Watt Color-Changing Spotlight</li> <li>2-Watt Color-Changing Waterfall Light</li> <li>150-Watt Low Voltage Transformer with Photocell</li> <li>3-Way Color-Changing Splitter</li> <li>25' Color-Changing Extension Cable</li> </ul>	<ul style="list-style-type: none"> <li>Automatic Dosing System for Ponds</li> <li>Maintain for Ponds water treatment</li> <li>Pond Powerhead</li> <li>Faux Driftwood 30"</li> </ul>
FINISHED POND SIZE	LINER & UNDERLAYMENT	INSTALLATION KIT	WELCOME KIT
21'W x 26'L x 2'D—may vary based on pond shape and rock size.	<ul style="list-style-type: none"> <li>45 mil EPDM Liner—25' x 30'</li> <li>Underlayment—750 sq. ft.</li> </ul>	<ul style="list-style-type: none"> <li>Black Silicone Sealant—4.7 oz.</li> <li>EPDM Liner Patch 6"</li> <li>Pond and Waterfall Foam Sealant</li> <li>PVC glue/cement</li> </ul>	Contains a gift for you, a USB with instructions and videos, and a starter water treatment.

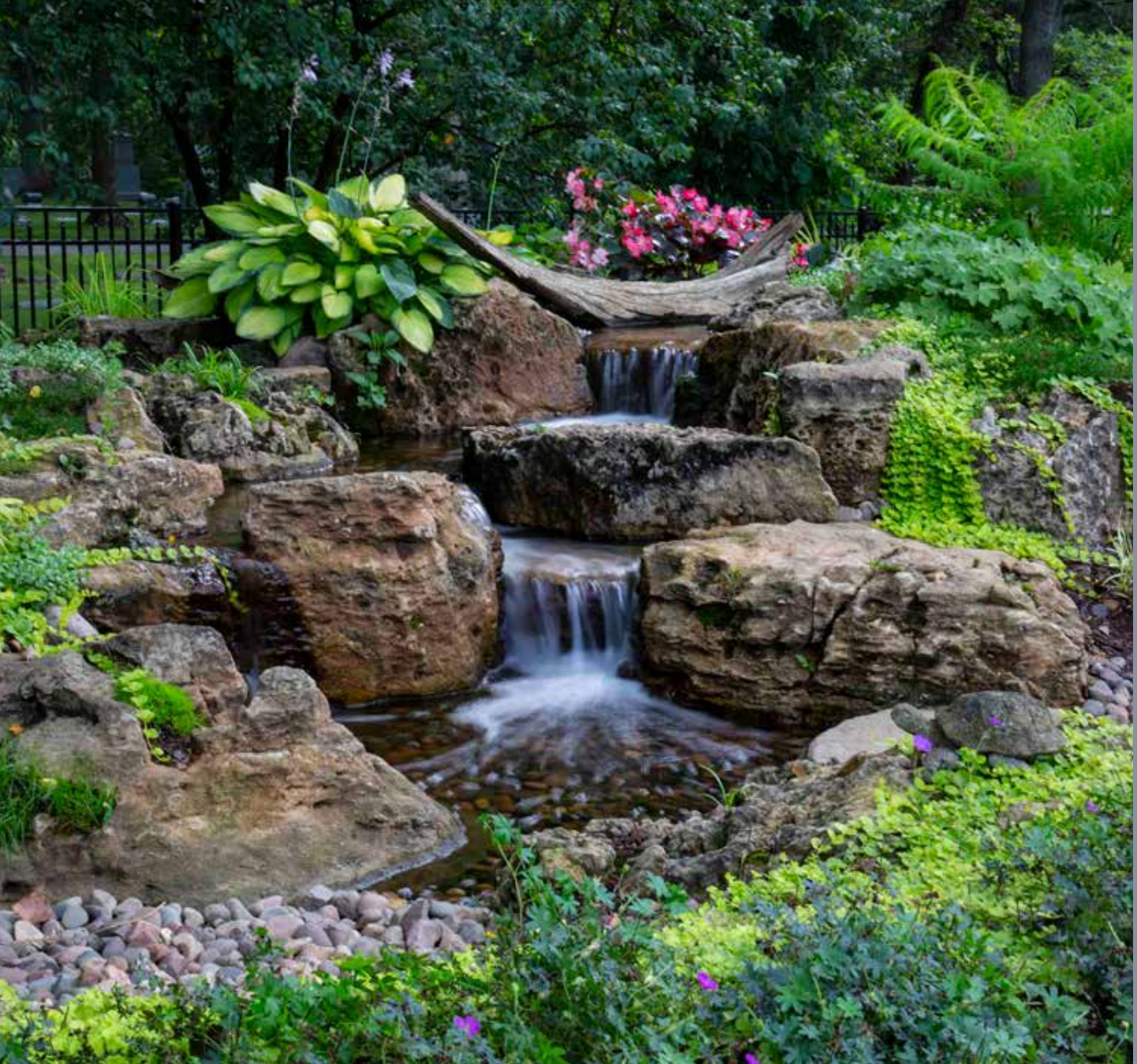

**A Pondless® Waterfall** is simply a re-circulating waterfall or stream without the presence of a pond. Aquascape Pondless Waterfalls work by pumping water contained in a large, in-ground reservoir up through the Waterfall Spillway, allowing the water to flow back down into the reservoir. This simple recirculation system requires very little maintenance, is easy to install, and ideal for families with young children or pets that love to play in water.

Selected waterfall kit components work well together to complement and enhance your existing landscape. In just one day you can enjoy the soothing sights and sounds that a waterfall adds to your yard.

## THE PONDLESS® WATERFALL KIT

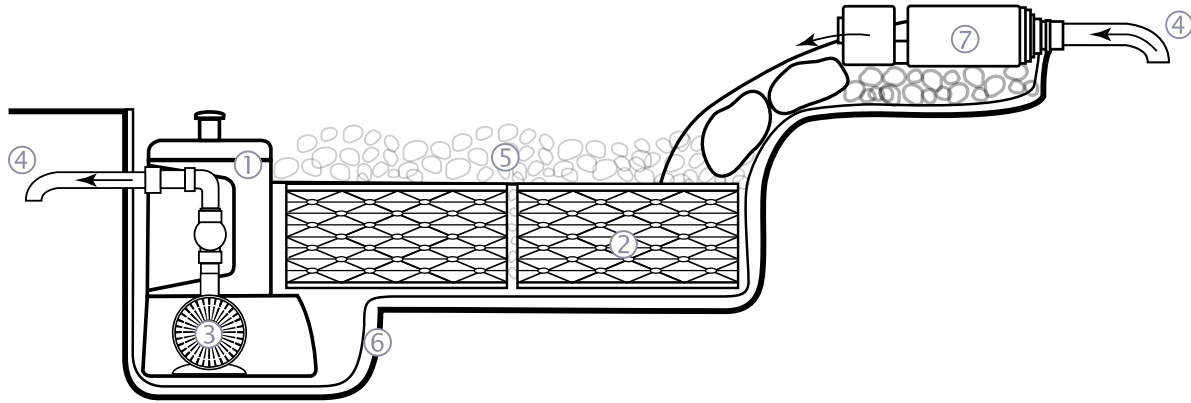

1. **Pondless® Waterfall Vault**—Houses and protects pump
2. **AquaBlox® Water Storage Modules**—Provides water storage
3. **Pond Pump**—Pumps water from the underground reservoir to the spillway to create a waterfall
4. **Pipe**—Directs water from the basin/reservoir to the Waterfall Spillway
5. **Rocks and Gravel (not included)**—Naturalizes the waterfall, protects the liner, and filters the water
6. **Liner and Underlayment**—Creates the form of the waterfall stream and holds water in the water storage area
7. **Waterfall Spillway**—Provides a smooth, flowing waterfall

## DIY BACKYARD PONDLESS® WATERFALL KIT

### DIY Backyard Waterfall Kit

#83001

Packaged Weight: 113 lb.

Packaged Dimensions: 41"L x 20"W x 25"H



SPILLWAY	RESERVOIR	PUMP	PLUMBING
<ul style="list-style-type: none"> <li>Waterfall Spillway 22"</li> </ul>	<ul style="list-style-type: none"> <li>Pondless® Waterfall Vault</li> <li>(2) AquaBloX® Small Water Storage Module</li> </ul>	<ul style="list-style-type: none"> <li>EcoWave® 2000 Pond Pump</li> </ul>	<ul style="list-style-type: none"> <li>Kink-Free 1.5" x 25'</li> </ul>
WATERFALL & STREAM SIZE	LINER AND UNDERLAYMENT	INSTALLATION KIT	WELCOME KIT
3 ft. waterfall and stream—may vary based on shape and rock size.	<ul style="list-style-type: none"> <li>45 mil EPDM Liner—10' x 12'</li> <li>Underlayment—105 ft²</li> </ul>	<ul style="list-style-type: none"> <li>Black Silicone Sealant—4.7 oz.</li> <li>Pond and Waterfall Foam Sealant</li> <li>PVC glue/cement</li> </ul>	Contains a gift for you, a USB with instructions and videos, and a starter water treatment.

## PROFESSIONAL PONDLESS® WATERFALL KITS

Aquascape professional Pondless® Waterfall kits are available in three sizes for those who wish to build a larger waterfall with contractor-grade products.

### Small Pondless® Waterfall Kit 6' Stream

#53038

Packaged Weight: 149 lb.

Packaged Dimensions: 37"L x 24"W x 28"H



SPILLWAY	RESERVOIR	PUMP & PLUMBING	WATER TREATMENT
<ul style="list-style-type: none"> <li>Waterfall Spillway 22"</li> </ul>	<ul style="list-style-type: none"> <li>Pondless® Waterfall Vault</li> <li>(3) AquaBloX® Small Water Storage Module</li> </ul>	<ul style="list-style-type: none"> <li>AquaSurge® 2000-4000 Adjustable Flow Pond Pump</li> <li>Flexible PVC Pipe—1.5" x 25'</li> <li>Dual Union Check Valve 2.0</li> </ul>	<ul style="list-style-type: none"> <li>Automatic Dosing System for Fountains</li> <li>Prevent for Fountains water treatment</li> </ul>
WATERFALL & STREAM SIZE	LINER AND UNDERLAYMENT	INSTALLATION KIT	WELCOME KIT
6 ft. waterfall and stream—may vary based on shape and rock size	<ul style="list-style-type: none"> <li>45 mil EPDM Liner —10' x 10' (reservoir) —8' x 10' (stream)</li> <li>Underlayment—100 sq. ft.</li> </ul>	<ul style="list-style-type: none"> <li>Black Silicone Sealant—4.7 oz.</li> <li>EPDM Liner Patch 6"</li> <li>Pond and Waterfall Foam Sealant</li> <li>PVC glue/cement</li> </ul>	Contains a gift for you, a USB with instructions and videos, and a starter water treatment.

## PROFESSIONAL PONDLESS® WATERFALL KITS

### Medium Pondless® Waterfall Kit 16' Stream

**#53039**  
with AquaSurge® 2000-4000  
Adjustable Flow Pond Pump 

**#53040**  
with 3-PL 3000  
Solids-Handling Pond Pump

**#53064**  
with SLD 4000-7000  
Adjustable Flow Pond Pump 



Packaged Weight: 298 lb.

Packaged Dimensions: 48"L x 40"W x 24"H Palletized

SPILLWAY & RESERVOIR	PUMP & PLUMBING	LED LIGHTING	WATER TREATMENT
<ul style="list-style-type: none"> <li>Waterfall Spillway 22"</li> <li>Pondless® Waterfall Vault</li> <li>(5) AquaBlox® Small Water Storage Module</li> </ul>	<ul style="list-style-type: none"> <li>Choice of pump above</li> <li>Flexible PVC Pipe—2" x 25'</li> <li>Dual Union Check Valve 2.0</li> </ul>	<ul style="list-style-type: none"> <li>(2) 1-Watt Waterfall Light</li> <li>60-Watt Low Voltage Transformer with Photocell</li> <li>3-Way Quick-Connect Splitter</li> <li>25' Quick-Connect Extension Cable</li> </ul>	<ul style="list-style-type: none"> <li>Automatic Dosing System for Fountains</li> <li>Prevent for Fountains water treatment</li> </ul>
WATERFALL & STREAM SIZE	LINER & UNDERLAYMENT	INSTALLATION KIT	WELCOME KIT
16 ft. waterfall and stream—may vary based on shape and rock size	<ul style="list-style-type: none"> <li>45 mil EPDM Liner –10' x 12' (reservoir) –10' x 20' (stream)</li> <li>Underlayment—120 sq. ft.</li> </ul>	<ul style="list-style-type: none"> <li>Black Silicone Sealant—4.7 oz.</li> <li>EPDM Liner Patch 6"</li> <li>Pond and Waterfall Foam Sealant</li> <li>PVC glue/cement</li> </ul>	Contains a gift for you, a USB with instructions and videos, and a starter water treatment.

### Large Pondless® Waterfall Kit 26' Stream

**#53041**  
with AquaSurge® 4000-8000  
Adjustable Flow Pond Pump 

**#53042**  
with 5-PL 5000  
Solids-Handling Pond Pump

**#53065**  
with SLD 5000-9000  
Adjustable Flow Pond Pump 



Packaged Weight: 379 lb.

Packaged Dimensions: 48"L x 40"W x 31"H Palletized

SPILLWAY & RESERVOIR	PUMP & PLUMBING	LED LIGHTING	WATER TREATMENT
<ul style="list-style-type: none"> <li>Waterfall Spillway 22"</li> <li>Pondless® Waterfall Vault with Extension</li> <li>(5) AquaBlox® Large Water Storage Module</li> </ul>	<ul style="list-style-type: none"> <li>Choice of pump above</li> <li>Flexible PVC Pipe—2" x 50'</li> <li>Dual Union Check Valve 2.0</li> </ul>	<ul style="list-style-type: none"> <li>(3) 1-Watt Waterfall Light</li> <li>60-Watt Low Voltage Transformer with Photocell</li> <li>3-Way Quick-Connect Splitter</li> <li>25' Quick-Connect Extension Cable</li> </ul>	<ul style="list-style-type: none"> <li>Automatic Dosing System for Fountains</li> <li>Prevent for Fountains water treatment</li> </ul>
WATERFALL & STREAM SIZE	LINER & UNDERLAYMENT	INSTALLATION KIT	WELCOME KIT
26 ft. waterfall and stream—may vary based on shape and rock size	<ul style="list-style-type: none"> <li>45 mil EPDM Liner –12' x 15' (reservoir) –10' x 30' (stream)</li> <li>Underlayment—180 sq. ft.</li> </ul>	<ul style="list-style-type: none"> <li>Black Silicone Sealant—4.7 oz.</li> <li>EPDM Liner Patch 6"</li> <li>Pond and Waterfall Foam Sealant</li> <li>PVC glue/cement</li> </ul>	Contains a gift for you, a USB with instructions and videos, and a starter water treatment.



## DELUXE PONDLESS® WATERFALL KITS

Aquascape deluxe Pondless® Waterfall kits include all the components found in standard medium and large Aquascape Pondless Waterfall kits, but are enhanced with the addition of the Faux Driftwood 35", and an LED color-changing light package. Connect the pump and lights to the Smart Control App and control them with your smartphone or tablet.



Deluxe Kits Include Smart Control Products for Wi-Fi Controllability

### Medium Deluxe Pondless® Waterfall Kit 16' Stream



#53068

Packaged Weight: 323 lb.  
Packaged Dimensions: 48"L x 40"W x 24"H Palletized



SPILLWAY & RESERVOIR	PUMP AND PLUMBING	COLOR-CHANGING LIGHTING	DELUXE ADD ONS
<ul style="list-style-type: none"> <li>Waterfall Spillway 22"</li> <li>Pondless® Waterfall Vault</li> <li>(5) AquaBlox® Small Water Storage Module</li> </ul>	<ul style="list-style-type: none"> <li>AquaSurge® 2000-4000 Adjustable Flow Pond Pump</li> <li>Flexible PVC Pipe—2" x 25'</li> <li>Dual Union Check Valve 2.0</li> </ul>	<ul style="list-style-type: none"> <li>Smart Control Hub</li> <li>(2) 2-Watt Color-Changing Waterfall Light</li> <li>60-Watt Low Voltage Quick-Connect Transformer</li> <li>3-Way Color-Changing Splitter</li> <li>25' Color-Changing Extension Cable</li> </ul>	<ul style="list-style-type: none"> <li>Automatic Dosing System for Fountains</li> <li>Prevent for Fountains water treatment</li> <li>Faux Driftwood 35"</li> </ul>
WATERFALL & STREAM SIZE	LINER & UNDERLAYMENT	INSTALLATION KIT	WELCOME KIT
16 ft. waterfall and stream—may vary based on shape and rock size.	<ul style="list-style-type: none"> <li>45 mil EPDM Liner —10' x 12' (reservoir) —10' x 20' (stream)</li> <li>Underlayment—120 sq. ft.</li> </ul>	<ul style="list-style-type: none"> <li>Black Silicone Sealant—4.7 oz.</li> <li>EPDM Liner Patch 6"</li> <li>Pond and Waterfall Foam Sealant</li> <li>PVC glue/cement</li> </ul>	Contains a gift for you, a USB with instructions and videos, and a starter water treatment.

### Large Deluxe Pondless® Waterfall Kit 26' Stream



#53069

Packaged Weight: 404 lb.  
Packaged Dimensions: 48"L x 40"W x 31"H Palletized



SPILLWAY & RESERVOIR	PUMP AND PLUMBING	COLOR-CHANGING LIGHTING	DELUXE ADD ONS
<ul style="list-style-type: none"> <li>Waterfall Spillway 22"</li> <li>Pondless® Waterfall Vault with Extension</li> <li>(5) AquaBlox® Large Water Storage Module</li> </ul>	<ul style="list-style-type: none"> <li>AquaSurge® 4000-8000 Adjustable Flow Pond Pump</li> <li>Flexible PVC Pipe—2" x 50'</li> <li>Dual Union Check Valve 2.0</li> </ul>	<ul style="list-style-type: none"> <li>Smart Control Hub</li> <li>(3) 2-Watt Color-Changing Waterfall Light</li> <li>60-Watt Low Voltage Quick-Connect Transformer</li> <li>3-Way Color-Changing Splitter</li> <li>25' Color-Changing Extension Cable</li> </ul>	<ul style="list-style-type: none"> <li>Automatic Dosing System for Fountains</li> <li>Prevent for Fountains water treatment</li> <li>Faux Driftwood 35"</li> </ul>
WATERFALL & STREAM SIZE	LINER & UNDERLAYMENT	INSTALLATION KIT	WELCOME KIT
26 ft. waterfall and stream—may vary based on shape and rock size	<ul style="list-style-type: none"> <li>45 mil EPDM Liner —12' x 15' (reservoir) —10' x 30' (stream)</li> <li>Underlayment—180 sq. ft.</li> </ul>	<ul style="list-style-type: none"> <li>Black Silicone Sealant—4.7 oz.</li> <li>EPDM Liner Patch 6"</li> <li>Pond and Waterfall Foam Sealant</li> <li>PVC glue/cement</li> </ul>	Contains a gift for you, a USB with instructions and videos, and a starter water treatment.



**With the Backyard Waterfall Landscape Fountain Kit**, it is easier than ever to install and enjoy your very own waterfall. This kit comes complete with everything you need to build a beautiful, one-of-a-kind, recirculating, Pondless® Waterfall in any space.

THE BACKYARD WATERFALL LANDSCAPE FOUNTAIN KIT

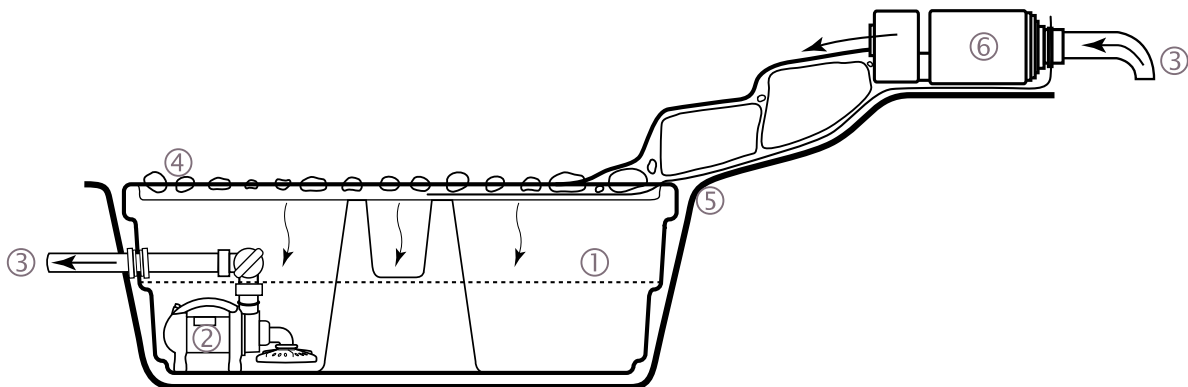

- 1. **AquaBasin® 45**—Provides a basin for water to be stored and protects the pump
- 2. **Pond Pump**—Pumps water from the water storage area back to the spillway to create a waterfall
- 3. **Pipe**—Directs water from the basin/reservoir to the Waterfall Spillway
- 4. **Rocks and Gravel (not included)**—Naturalizes the waterfall and filters the water
- 5. **Liner and Underlayment**—Creates the form of the waterfall and stream
- 6. **Waterfall Spillway**—Provides a smooth, flowing waterfall

BACKYARD WATERFALL LANDSCAPE FOUNTAIN KIT

Backyard Waterfall Landscape Fountain Kit

#83013

Packaged Weight: 175 lb.  
Packaged Dimensions: 48"L x 40"W x 35"H Palletized



SPILLWAY	RESERVOIR	PUMP	PLUMBING
<ul style="list-style-type: none"> <li>Waterfall Spillway 12"</li> </ul>	<ul style="list-style-type: none"> <li>AquaBasin® 45</li> </ul>	<ul style="list-style-type: none"> <li>AquaSurge® 2000 Pond Pump</li> </ul>	<ul style="list-style-type: none"> <li>Flexible PVC—1.5" x 15'</li> <li>AquaSurge® Low Suction Intake Attachment</li> </ul>
WATERFALL & STREAM SIZE	LINER AND UNDERLAYMENT	INSTALLATION KIT	WELCOME KIT
3 ft. waterfall and stream—may vary based on shape and rock size	<ul style="list-style-type: none"> <li>45 mil EPDM Liner—7.5' x 7.5'</li> <li>(2) Underlayment—7.5' x 1'</li> </ul>	<ul style="list-style-type: none"> <li>Black Silicone Sealant—4.7 oz.</li> <li>Pond and Waterfall Foam Sealant</li> <li>PVC glue/cement</li> </ul>	Contains a gift for you, a USB with instructions and videos, and a starter water treatment.



**Aquascape Landscape Fountain Kits** come with all the necessary components to install a recirculating fountain in just a few hours. A sub-surface basin holds the water and pump, which pushes the water up through the fountain for a stunning display. Install just one fountain, or group several together for a truly unique water feature. Add decorative rock to complete your fountain. Then sit back and enjoy the soothing sights and sounds of running water.

## THE LANDSCAPE FOUNTAIN KIT

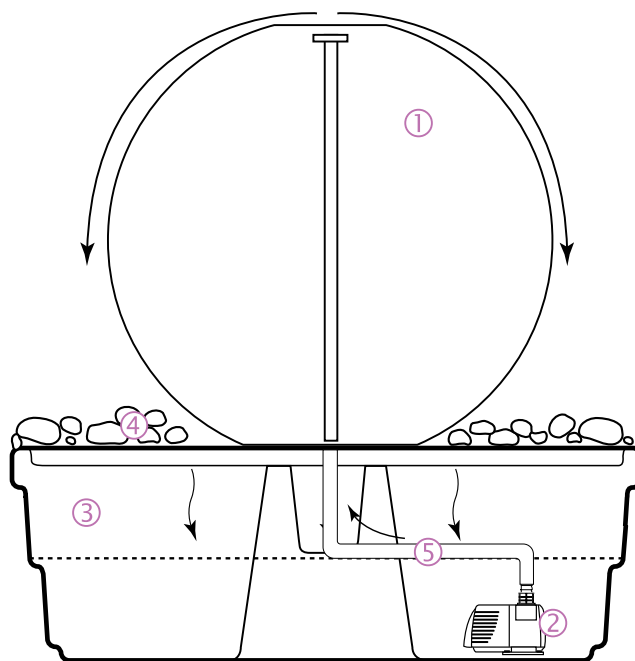

- 1. Fountain**—Choose from any one of the many Aquascape fountain options
- 2. Pond Pump**—Pumps water from the underground reservoir through the center of the fountain
- 3. AquaBasin® 45**—Provides a basin for water to be stored and protects the pump
- 4. Rocks and Gravel (not included)**—Disguises the AquaBasin and naturalizes the water feature
- 5. Pipe**—Directs water from the basin to the fountain

LANDSCAPE FOUNTAIN KITS

Aquascape landscape fountain kits come complete with all the materials needed to create a beautiful focal point in any outdoor space, including an AquaBasin® 45, tubing, and the properly-sized pump.



**Medium Stacked Slate Sphere Landscape Fountain Kit**

**#78290**

Pump: Ultra 1500 Pond Pump  
 Packaged Weight: 195 lb.  
 Packaged Dimensions: 40"L x 48"W x 46"H



**Medium Stacked Slate Urn Landscape Fountain Kit**

**#58090**

Pump: Ultra 1100 Pond Pump  
 Packaged Weight: 180 lb.  
 Packaged Dimensions: 40"L x 48"W x 54"H



**Medium Scalloped Urn Landscape Fountain Kit**

**#78270**

Pump: Ultra 1100 Pond Pump  
 Packaged Weight: 145 lb.  
 Packaged Dimensions: 40"L x 48"W x 52"H



**Medium Rippled Urn Landscape Fountain Kit**

**#78271**

Pump: Ultra 1100 Pond Pump  
 Packaged Weight: 164 lb.  
 Packaged Dimensions: 40"L x 48"W x 67"H



## LANDSCAPE FOUNTAIN KITS

Aquascape landscape fountain kits come complete with all the materials needed to create a beautiful focal point in any outdoor space, including an AquaBasin® 45, tubing, and the properly-sized pump.



**Spillway Bowl and Basin  
Landscape Fountain Kit**

**#58087**

Pump: Ultra 2000 Pond Pump  
 Pipe: Pre-Cut Kink-Free—3/4" x 12.5'  
 Packaged Weight: 380 lb.  
 Packaged Dimensions: 40"L x 48"W x 66"H



**Stacked Slate Spillway Wall 32"  
Landscape Fountain Kit**

**#78269**

Pump: Ultra 2000 Pond Pump  
 Pipe: (3) Clear Vinyl Tubing  
 Packaged Weight: 157 lb.  
 Packaged Dimensions: 40"L x 48"W x 54"H



## LANDSCAPE FOUNTAIN KITS

Aquascape landscape fountain kits come complete with all the materials needed to create a beautiful focal point in any outdoor space, including an AquaBasin® 45, tubing, and the properly-sized pump.



**Mongolian Basalt Column 30"  
Landscape Fountain Kit**

**#58065**

Pump: Ultra 800 Pond Pump  
 Pipe: Pre-Cut Kink-Free—3/4" x 6'  
 Packaged Weight: 700 lb.  
 Packaged Dimensions: 40"L x 48"W x 31"H



**Mongolian Basalt Columns Set of 3  
Landscape Fountain Kit**

**#58089**

Pump: Ultra 2000 Pond Pump  
 Pipe: Pre-Cut Kink-Free—3/4" x 15'  
 Packaged Weight: 963 lb.  
 Packaged Dimensions: 40"L x 48"W x 31"H

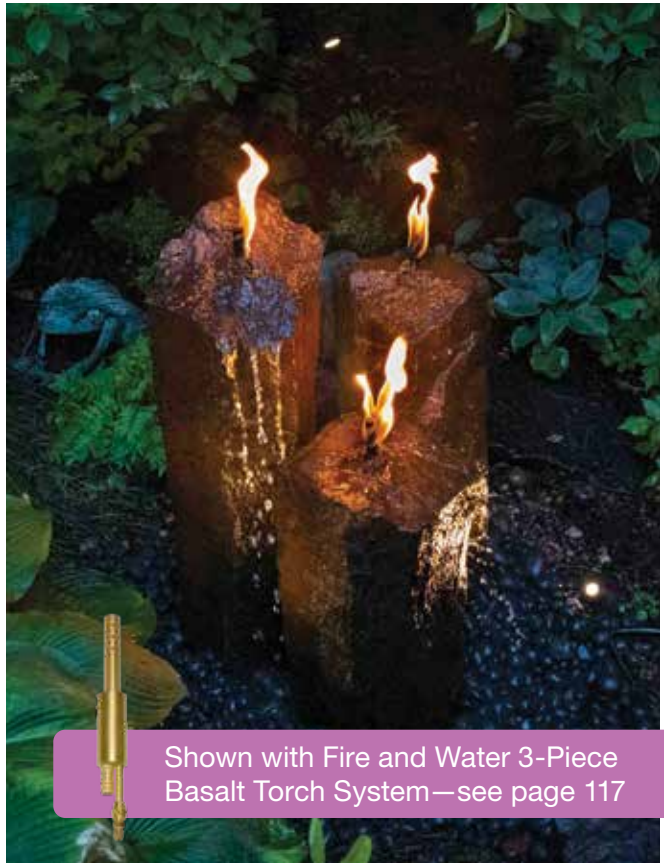

Shown with Fire and Water 3-Piece Basalt Torch System—see page 117





**Two forms of filtration** are critical to maintaining a healthy ecosystem pond: mechanical and biological. Ecosystem ponds process fish waste, uneaten fish food, leaves, debris and runoff from lawns through mechanical and biological filtration.

In ecosystem ponds, mechanical filtration is provided by a pond skimmer and biological filtration is provided by a BioFalls® Filter.

To keep your pond or water feature looking beautiful, it is important to provide proper filtration. Features and benefits of Aquascape filters are noted in the following pages, making it simple and easy to select the correct filter for your application.

## POND SKIMMER FILTERS

Pond skimmers are designed to eliminate water quality problems and reduce maintenance by removing debris before it sinks to the bottom of the pond, allowing a pond to be installed anywhere, even beneath trees. Because the skimmer removes debris before it reaches the pump, it acts as a pre-filter, reducing pump maintenance and making pump access quick and easy. All pond skimmers include a limited lifetime warranty.

U.S. PATENT 7,144,501



**Signature Series 200  
Pond Skimmer**

#43020



**Signature Series 400  
Pond Skimmer**

#43021



**Signature Series 1000  
Pond Skimmer**

#43022

MODEL	200	400	1000
POND SIZE	Up to 200 sq. ft.	Up to 400 sq. ft.	Up to 1,000 sq. ft.
MAX FLOW RATE	Up to 3,000 GPH / 11,000 LPH	Up to 4,000 GPH / 15,000 LPH	Up to 10,000 GPH / 37,500 LPH*
RECOMMENDED PUMPS	EcoWave and AquaSurge Pumps	EcoWave, AquaSurge, AquaSurge Adjustable Flow, and PL Pumps	EcoWave, AquaSurge, AquaSurge and SLD Adjustable Flow, and PL Pumps
WEIR SIZE	6"	6"	8"
ADJUSTABLE HEIGHT FACE PLATE	—	—	✓
LOCKING WEIR DOOR	—	✓	✓
LEAF & DEBRIS NET	✓	—	—
LEAF & DEBRIS RIGID BASKET	—	✓	✓
FILTER BRUSH CARTRIDGE	Optional	—	—
OVERFLOW	Optional	✓	✓
FILTER MAT	—	✓	✓
FAUX-ROCK LID	—	✓	✓
DIMS	20"L x 17.5"W x 17.5"H	21.4"L x 18"W x 21"H	21"L x 22"W x 26.5"H
WARRANTY	Limited Lifetime	Limited Lifetime	Limited Lifetime
PACKAGED WEIGHT	14.75 lb.	25 lb.	34 lb.
PACKAGED DIMS	22.5"L x 20"W x 18.5"H	25.75"L x 20.5"W x 25"H	25"L x 24"W x 26.75"H

\* **NOTE:** 12-PN 10000 and AquascapePRO 10000 pumps are too large to fit in these skimmers. Multiple pumps can be used to achieve up to 10,000 GPH.

## POND SKIMMER FILTERS



### FEATURES OF THE SIGNATURE SERIES 200 POND SKIMMER

1. Durable **custom lid** provides protection of the filter components
2. A floating **6" weir**, designed to raise and lower to match the water level in the pond
3. Large volume, **debris net** makes maintenance easier than ever
4. Optional **filter brush** (#99772) handles any debris that finds its way past the debris net (sold separately)
5. Optional **overflow** (#88036) helps maintain proper water level in an overflow situation (sold separately)

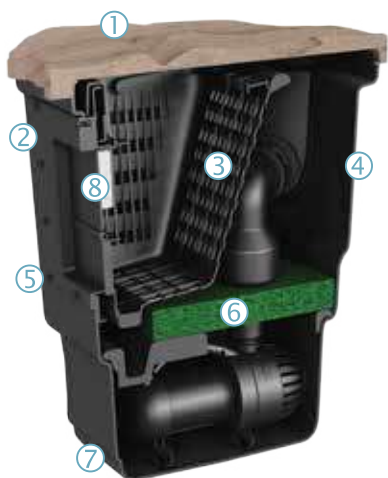

### FEATURES OF THE SIGNATURE SERIES 400 AND 1000 POND SKIMMER

1. Natural looking **faux-rock lid** conceals the filter in the surrounding landscape
2. **Patented adjustable faceplate** allows you to adjust the water level after installation (1000 only)
3. Large volume, **rigid debris basket** makes maintenance easier than ever
4. **Injection molded fittings** provide professional, watertight seals
5. **Corrosion-resistant, non-cross-threading hardware** stands up to the elements
6. Rigid **filter mat** effectively removes smaller sediment and debris
7. **Rounded shape** provides maximum strength
8. Innovative locking **weir door** for ease of maintenance

## APPLICATION

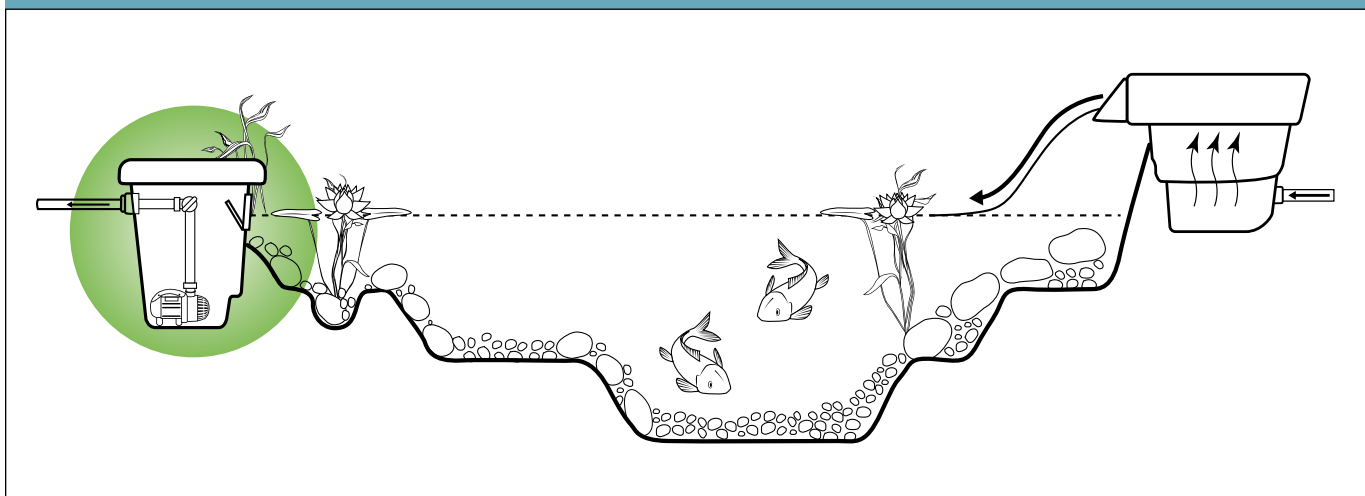

## BIOFALLS® FILTERS

Aquascape Signature Series BioFalls® Filters provide the most filtration and highest water flows in the market. Durable, rotationally-molded polyethylene construction ensures maximum strength, and all Signature Series BioFalls Filters include a limited lifetime warranty.



**Signature Series 1000  
BioFalls® Filter**

**#99774**



**Signature Series 2500  
BioFalls® Filter**

**#09020**



**Signature Series 6000  
BioFalls® Filter  
with 2" Bulkhead**

**#29319**



**Signature Series 6000  
BioFalls® Filter  
with 3" Bulkhead**

**#29384**

MODEL	1000	2500	6000 WITH 2" BULKHEAD	6000 WITH 3" BULKHEAD
FILTERS PONDS UP TO	1,000 gal. / 3,500 L	2,500 gal. / 9,000 L	6,000 gal. / 22,500 L	6,000 gal. / 22,500 L
MAX FLOW RATE	Up to 3,000 GPH / 11,000 LPH	Up to 5,000 GPH / 18,500 LPH	Up to 15,000 GPH / 56,500 LPH	Up to 15,000 GPH / 56,500 LPH
SPILLWAY WIDTH	15"	21.5"	28"	28"
BULKHEAD PORT	Single 2"	Dual 2"	Dual 2"	Dual 3"
FITTINGS INCLUDED	1.5" PVC Slip and 1.5" Kink-Free Insert	Two 2" PVC Slip	Two 2" PVC Slip	Two 3" PVC Slip
ROCK TRAY	Optional	✓	✓	✓
FILTER MATS	Two Included	Two Included	Two Included	Two Included
BIOBALLS (RECOMMENDED)	Holds 100*	Holds 200*	Holds 400*	Holds 400*
FILTER MEDIA NETS	One Included	Two Included	Three Included	Three Included
DIMS	17.5"L x 20.5"W x 17"H	29.5"L x 24"W x 20"H	40"L x 45"W x 29.5"H	40"L x 45"W x 29.5"H
WARRANTY	Limited Lifetime	Limited Lifetime	Limited Lifetime	Limited Lifetime
PACKAGED WEIGHT	11 lb.	28.8 lb.	55 lb.	57 lb.
PACKAGED DIMS	18.5"L x 20.5"W x 17.5"H	30"L x 24"W x 24"H	40"L x 45"W x 29.5"H	40"L x 45"W x 29.5"H

\* NOTE: BioBalls not included. For more information, see page 32.

## BIOFALLS® FILTERS



### FEATURES OF THE BIOFALLS® 1000 FILTER

1. BioFalls **filter media net** (BioBalls sold separately)
2. Two standard biological **filter mats**
3. Optional **BioBalls** filter media (#98464) supports effective biological filtration by providing textured surface area for beneficial bacteria to grow and colonize (BioBalls sold separately)
4. Optional **rock tray** (#98285) holds rocks, plants, and gravel, naturalizing the filter into the surrounding landscape (rock tray sold separately)



### FEATURES OF THE BIOFALLS® 2500 AND 6000 FILTER

1. Reversible **waterfall lip** provides the option of using a natural stone spillway
2. Removable **rock tray** holds rocks, plants, and gravel, helping to naturalize the filter into the landscape
3. BioFalls **filter media net** (BioBalls sold separately)
4. **Corrosion-resistant, non-cross-threading hardware** stands up to the elements
5. Two Poly-Flo ESA biological **filter mats** provide 50% more surface area than traditional filter mats
6. Two **bulkhead ports** provide multiple plumbing options
7. Filter **support rack** ensures evenly distributed water flow through filter mats and provides structural strength to the walls of the filter
8. **Rounded shape** provides maximum strength and makes it easy to camouflage into the landscape

## APPLICATION

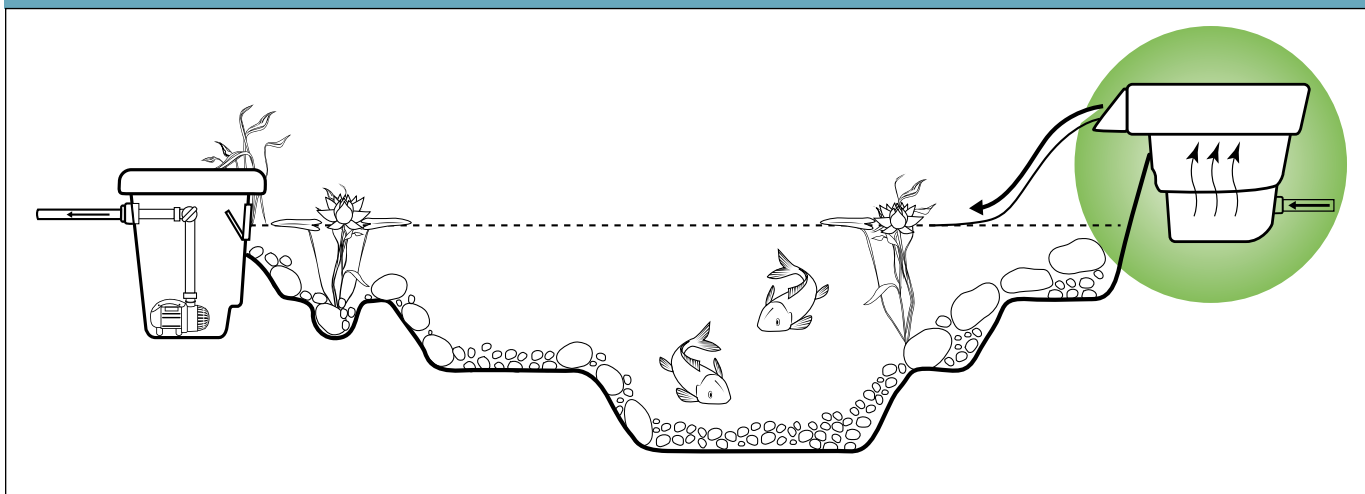

## POND WATERFALL FILTER

The following filters are ideal for smaller ponds, including preformed ponds or container water gardens. These filters can be easily incorporated into existing ponds, and are ideal for use with Aquascape Ultra, EcoWave®, AquaSurge®, or AquaForce® Pumps.



**Pond Waterfall Filter**  
#77020

Packaged Weight: 11 lb.

- Provides efficient mechanical and biological filtration for ponds up to 1,000 gallons
- Includes rigid filter mat and biological filter media net



### FEATURES OF THE POND WATERFALL FILTER

1. Durable, **circular shape** provides maximum strength
2. **Filter mat** provides ideal mechanical and biological filtration
3. Included **filter media net** holds biological filter media (filter media sold separately)
4. **Filter rack** provides support for filter media
5. **Fitting** accepts 1", 1¼", and 1½" pipe sizes

## POND FILTER URN



#77006 shown

**Small Pond Filter Urn**  
#77006

Packaged Weight: 16.1 lb.

**Large Pond Filter Urn**  
#77011

Packaged Weight: 25 lb.



### FEATURES OF THE POND FILTER URN

1. Removable **filter lid** allows easy access for cleaning
2. Decorative **filter housing** can be easily incorporated into any setting
3. **Inlet hose** accommodates most small pumps
4. **Mechanical filtration** removes debris
5. **Ceramic filtration rings** provide bacteria with a large surface area for colonization

MODEL	SMALL POND FILTER URN	LARGE POND FILTER URN	POND WATERFALL FILTER
POND VOLUME	500 gal.	1,500 gal.	1,000 gal.
MAX FLOW RATE	400 GPH / 1,500 LPH	1,100 GPH / 4,000 LPH	5,000 GPH / 18,500 LPH
INLET FITTING DIMS	½"	¾"	1", 1.25", 1.5"
FILTER DIMS	20"L x 11"W x 11"H	28"L x 15.5"W x 15.5"H	20"L x 15"W x 12.5"H

## SUBMERSIBLE POND FILTER

The Aquascape Submersible Pond Filter provides efficient mechanical and biological filtration. This inconspicuous filter can be added to the intake of almost any submersible water pump, resulting in crystal clear water while reducing pond pump maintenance.



**Submersible Pond Filter**  
#95110

MODEL	SUBMERSIBLE POND FILTER
POND VOLUME	Up to 800 gal.
RECOMMENDED PUMP	Ultra 1100 Water Pump (#91008)
FITTING INCLUDED	¾", 1", 1.25"
PRE-FILTRATION SPONGE	✓
CERAMIC FILTRATION RINGS	✓
FILTER DIMS	13"L x 11"W x 5"H
PACKAGED WEIGHT	11 lb.
PACKAGED DIMS	12"L x 6"W x 12.75"H



### FEATURES OF THE SUBMERSIBLE POND FILTER

1. The cage provides a large surface area and small openings which prevent large debris from clogging the filter
2. The **pre-filtration sponge** provides efficient mechanical and biological filtration and dramatically reduces pump maintenance
3. Included **threaded intake and multi-hose adapters** make it easy to adapt to most pond pumps with a small piece of kink-free pipe or threaded fitting
4. **Ceramic filtration rings** provide surface area for beneficial bacteria to colonize, providing efficient biological filtration

## CONTAINER WATER GARDEN FILTER

The Aquascape Container Water Garden Filter is a complete solution for container water gardens or containers with stagnant or non-moving water, including birdbaths and water containers holding pond plants like lotus or waterlilies. The magnetically-driven motor is simple and easy to maintain and extremely energy-efficient. The durable pre-filter water intake design prevents clogging and reduces pump maintenance.



**Container Water Garden Filter**  
#77005

MODEL	CONTAINER WATER GARDEN FILTER
CONTAINER WATER GARDEN VOLUME	Up to 50 gal.
FILTER DIMS	2"L x 1.5"W x 7"H
PACKAGED WEIGHT	1 lb.
PACKAGED DIMS	4.25"L x 3.25"W x 8"H

## BIOBALLS BIOLOGICAL FILTER MEDIA

Aquascape BioBalls provide a textured surface area for beneficial bacteria to colonize and grow, keeping pond water clean, clear, and healthy. BioBalls are easy to clean, long lasting, and lightweight, making them the ideal filtration media for use in biological filters such as BioFalls®.



**BioBalls Biological Filter Media**  
100 Count  
**#98464**

Packaged Weight: 2.25 lb.  
Packaged Dimensions: 8"L x 8"W x 6.5"H

- 100 BioBalls
- 1.5" diameter
- Media net included



**BioBalls Biological Filter Media**  
1,000 Count  
**#56014**

Packaged Weight: 24 lb.  
Packaged Dimensions: 18"L x 12"W x 14"H

- 1,000 BioBalls
- 1.5" diameter
- Media nets sold separately



**BioBalls Filter Media Net**  
**#29069**

Packaged Weight: .25 lb.  
Packaged Dimensions: 7.25"L x 10.5"W x 1"H

## FILTER ROLLS AND MATS

Aquascape filter media rolls and rigid filter mats are designed to fit a wide variety of pond skimmers and filters. They can be cut to size easily using a sharp knife or pair of scissors.



**Dense Filter Media Roll**  
1" Thick  
**#99325**

Packaged Weight: 8.75 lb.  
Dimensions: 10"L x 56"W



**Coarse Filter Media Roll**  
1.25" Thick  
**#99321**

Packaged Weight: 8.25 lb.  
Dimensions: 10"L x 56"W



**Coarse Filter Media Roll**  
2" Thick  
**#99323**

Packaged Weight: 10 lb.  
Dimensions: 10"L x 56"W



**Low Density Rigid Filter Mat**  
1.5" Thick  
**#80003**

Packaged Weight: 4.25 lb.  
Dimensions: 24"L x 39"W



**Medium Density Rigid Filter Mat**  
1.5" Thick  
**#80004**

Packaged Weight: 3.5 lb.  
Dimensions: 24"L x 39"W



**High Density Rigid Filter Mat**  
1.5" Thick  
**#80005**

Packaged Weight: 3.25 lb.  
Dimensions: 24"L x 39"W



## ULTRAKLEAR® UV CLARIFIER

The Aquascape UltraKlear® UV Clarifier uses a technologically-advanced T5 high-output UVC bulb to eliminate green water. The Aquascape UltraKlear UV Clarifier features a swirl sleeve which directs the water around the UV bulb, maximizing contact time and increasing UV efficiency up to 50% over traditional UV clarifiers. It is simple and easy to use, install, and maintain and can be mounted horizontally or vertically.



#95037 shown

UltraKlear® 1000 UV Clarifier

#95036

UltraKlear® 2500 UV Clarifier

#95037

UltraKlear® 5000 UV Clarifier

#95038

MODEL	1000	2500	5000
AVERAGE POND SIZE RECOMMENDATION	1,000 gal. / 3,500 L	2,500 gal. / 9,000 L	5,000 gal. / 18,500 L
MAX FLOW RATE	500 GPH / 1,500 LPH	1,000 GPH / 3,500 LPH	1,500 GPH / 5,500 LPH
UV WATTAGE	14	28	55
POWER CORD LENGTH	20'	20'	20'
DISCHARGE HOSE DIA	1", 1.25", 1.5"	1", 1.25", 1.5"	1", 1.25", 1.5"
DIMS	23.5"L x 5.5"W x 3.75"H	33.5"L x 5.5"W x 3.75"H	43"L x 5.5"W x 3.75"H
WARRANTY	3-Year Limited	3-Year Limited	3-Year Limited
PACKAGED WEIGHT	6.5 lb.	8.75 lb.	10 lb.
PACKAGED DIMS	24"L x 11"W x 4"H	34"L x 9.5"W x 4"H	44.5"L x 9.5"W x 4"H



### FEATURES OF THE ULTRAKLEAR UV CLARIFIER

1. Narrow **contact chamber** increases effectiveness of UV light
2. **Internal sleeve** increases contact time, thus increasing efficiency
3. Additional **side water flow output** allows for easier installation
4. High-output **(HO) T5 bulb** maximizes effectiveness
5. UV clarifier/sterilizer on/off **LED indicator light**
6. **Mounting brackets** make it simple to attach the unit to a vertical surface
7. High-quality **quartz sleeve** maximizes bulb output
8. Mechanical **safety switch** automatically turns off bulb when the ballast/bulb is removed
9. **Electronic ballast** ensures optimum wattage and bulb output
10. **Fittings** included (2) 1.5" rotational ball outlet, (4) 1", 1.25", 1.5" multi-hose fittings, (2) elbows, (2) adapters, and (2) mounting brackets

2-Way Flow Control Valve  
Available—see page 141



## ULTRAKLEAN™ POND FILTERS

Aquascape UltraKlean™ pond filters provide optimum water quality and crystal clear pond water. The unique sponge-free design minimizes maintenance and maximizes efficient mechanical and biological filtration. The simple-to-use cleaning feature allows the unit to be backwashed in less than five minutes without opening the canister or getting hands dirty. UltraKlean Pond Filters include a high-output UV clarifier and electronic bulb-saver function that eliminates green water caused by suspended algae.



#95054 shown

UltraKlean™ 2000 Pond Filter

#95053

UltraKlean™ 3500 Pond Filter

#95054

MODEL	2000	3500
AVERAGE POND SIZE RECOMMENDATION	2,000 gal. / 7,500 L	3,500 gal. / 13,000 L
MAX FLOW RATE	2,700 GPH / 10,000 LPH	5,200 GPH / 19,500 LPH
UV WATTAGE	14	28
POWER CORD LENGTH	20'	20'
DISCHARGE HOSE DIA	1", 1.25", 1.5"	1", 1.25", 1.5"
DIMS	13"L x 13"W x 17"H	13"L x 13"W x 21.5"H
WARRANTY	3-Year Limited	3-Year Limited
PACKAGED WEIGHT	17 lb.	22 lb.
PACKAGED DIMS	14"L x 14"W x 18"H	14"L x 14"W x 22.5"H



### FEATURES OF THE ULTRAKLEAN™ POND FILTER

1. UV clarifier/sterilizer on/off **LED indicator light**
2. **Cleaning indicator light** signals when it's time to backwash
3. **Electronic ballast** ensures optimum wattage and bulb output
4. **UV bulb-saver timer** feature maximizes bulb life and provides an ideal time to add bacteria (6-hour, 12-hour, or 24-hour timer options)
5. **Backwash valve** and discharge shutoff valve make it easy to quickly clean the filter
6. **Water inlet diffuser** evenly distributes debris, maximizing mechanical filtration
7. **UV clarifier/sterilizer** eliminates single-celled algae commonly known as green water
8. **BioBalls** provide efficient biological/mechanical filtration
9. **Backwash swirl diffuser** efficiently churns the water to clean the filter media
10. **Fittings** Include: (6) 1", 1.25", 1.5" multi-hose adapters, backwash cap, (8) washers, backflush valve, and threaded adapter

## ULTRAKLEAN™ POND FILTRATION KITS

Aquascape UltraKlean™ pond filtration kits take the guesswork out of selecting the correct pump and filtration combination for any new or existing pond. Three kit sizes are available, ensuring there is a filtration kit for almost any pond.



#95059 shown

### UltraKlean™ 1500 Pond Filtration Kit

#95058

### UltraKlean™ 2500 Pond Filtration Kit

#95059

### UltraKlean™ 3500 Pond Filtration Kit

#95060

MODEL	1500	2500	3500
POND SIZE	Up to 1,500 gal. / 5,500 L	Up to 2,500 gal. / 9,000 L	Up to 3,500 gal. / 13,000 L
ULTRAKLEAN POND FILTER SIZE	UltraKlean 2000	UltraKlean 2000	UltraKlean 3500
UV CLARIFIER/STERILIZER	14-Watt	14-Watt	28-Watt
SOLIDS-HANDLING POND PUMP	AquaForce 1000	AquaForce 2700	AquaForce 5200
PIPE	Kink-Free Pipe – 1.5" x 25'	Kink-Free Pipe – 1.5" x 25'	Kink-Free Pipe – 1.5" x 25'
STAINLESS STEEL HOSE CLAMPS	4	4	7
2-WAY FLOW CONTROL VALVE	—	—	✓
PACKAGED WEIGHT	39.75 lb.	40 lb.	48.5 lb.
PACKAGED DIMS	23.5"L x 21.5"W x 21"H	23.5"L x 21.5"W x 21"H	23.5"L x 21.5"W x 23.5"H

### APPLICATION

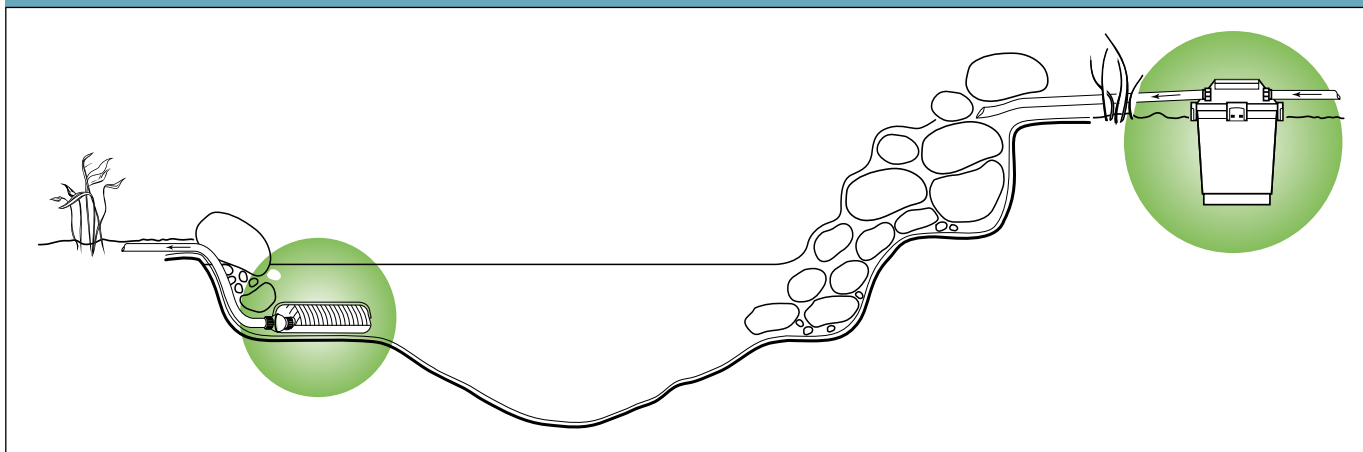

## WATERFALL SPILLWAY

The Aquascape Waterfall Spillway is a cost-effective solution to create the starting point of a beautiful waterfall and stream. Use it to create smooth, consistent, leak-free water flow. Pair multiple Waterfall Spillways together to design larger, more complex waterfall configurations.



Waterfall Spillway 12"

#77023



Waterfall Spillway 22"

#77000

MODEL	WATERFALL SPILLWAY 12"	WATERFALL SPILLWAY 22"
SPILLWAY WIDTH	12"	22"
BULKHEAD PORT	Single 2"	Single 2"
FITTINGS INCLUDED	2" PVC Slip, and 1.5" Barbed Hose Fitting	2" PVC Slip, and 1.5" Barbed Hose Fitting
MAX FLOW RATE	4,000 GPH / 15,000 LPH	7,500 GPH / 28,000 LPH
SPILLWAY DIMS	10.5"L x 14"W x 5"H	17.5"L x 24"W x 5"H
PACKAGED WEIGHT	4.5 lb.	9 lb.
PACKAGED DIMS	14"L x 15"W x 5.5"H	24"L x 17"W x 5"H



### FEATURES OF THE WATERFALL SPILLWAY

1. **Durable design** allows boulders, logs, or other landscape material to be set directly on top to camouflage the spillway into the surrounding landscape
2. **Watertight connection** using the fitting on the back
3. **Wide spillway opening** handles high flow rates
4. **Internal barriers** provide a smooth-flowing waterfall

### APPLICATION

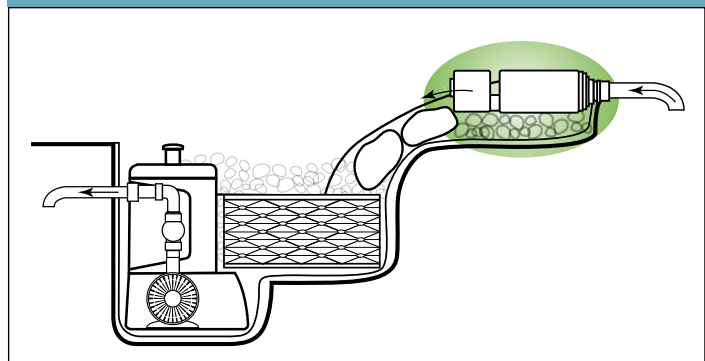

## PONDLESS® WATERFALL VAULT

The Pondless® Waterfall Vault is the ideal pump vault for use in Pondless Waterfalls, rainwater harvesting systems, and large fountains, effectively protecting the pump and simplifying maintenance. It is simple to install and maintain and fits a wide range of pump sizes and flow rates. It is also perfect for use with the AquaBlox® Water Storage Modules, and the Pondless Waterfall Vault Extensions can be used to extend the height for deeper applications.



Pondless® Waterfall Vault  
#49000



Pondless® Waterfall Vault Extension  
#49001

MODEL	PONDLESS WATERFALL VAULT	PONDLESS WATERFALL VAULT EXTENSION
MAX FLOW RATE	Up to 12,500 GPH / 47,000 LPH	—
ACCESS OPENING DIMS	16"L x 16"W	16"L x 16"W
DIMS	23"L x 17"W x 25.5"H	16"L x 16"W x 9"H
PACKAGED WEIGHT	14 lb.	5 lb.
PACKAGED DIMS	23"L x 18"W x 22.5"H	16"L x 16"W x 10"H

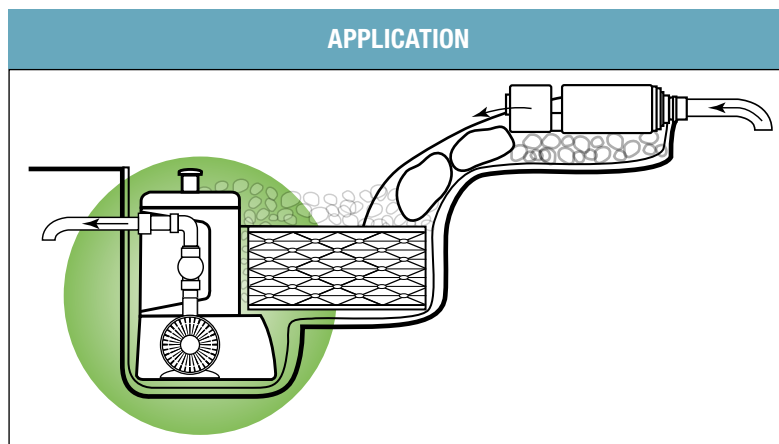

### FEATURES OF THE PONDLESS® WATERFALL VAULT

1. Built-in water level **inspection port** allows the lid to be buried out of sight
2. Extra **wide opening** provides easy pump access
3. Excellent water circulation through **water intakes**
4. **Large interior** fits a wide range of pump sizes

## AQUABLOX® WATER STORAGE MODULES

AquaBlox® Water Storage Modules provide an efficient way to maximize water storage capacity in Pondless® Waterfall reservoirs, rainwater harvesting systems, and permeable paver applications. They allow over 3 times more water storage capacity than gravel and hold approximately 7.4 gallons of water per cubic foot, compared to gravel, which holds approximately 2.2 gallons of water per cubic foot. Extra water storage capacity means less time topping off the reservoir due to evaporation. It is also easier to clean and less prone to clogging than traditional gravel basins. Construction with AquaBlox requires a smaller footprint than reservoirs constructed with gravel resulting in fewer labor hours to excavate and move gravel, as well as less liner and geotextile underlayment.



**AquaBlox® Small Water Storage Module**  
#29491

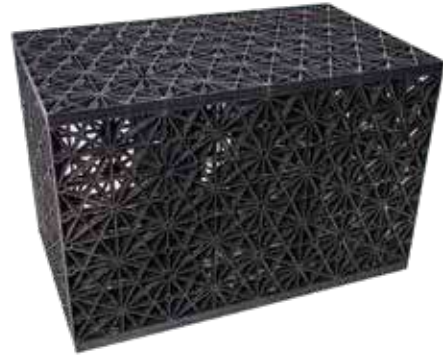

**AquaBlox® Large Water Storage Module**  
#29492

MODEL	SMALL	LARGE
VOLUME	17 gal. / 64.35 L	32 gal. / 121.13 L
LOAD BEARING WEIGHTS	5,472 lb./sq. ft.	5,472 lb./sq. ft.
DIMS	26.5"L x 16"W x 9.5"H	26.5"L x 16"W x 17.5"H
PACKAGED WEIGHT	11 lb.	16 lb.
PACKAGED DIMS	27"L x 16"W x 4"H	27"L x 16"W x 6"H

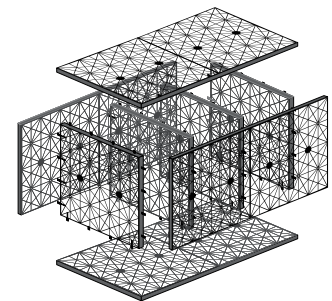
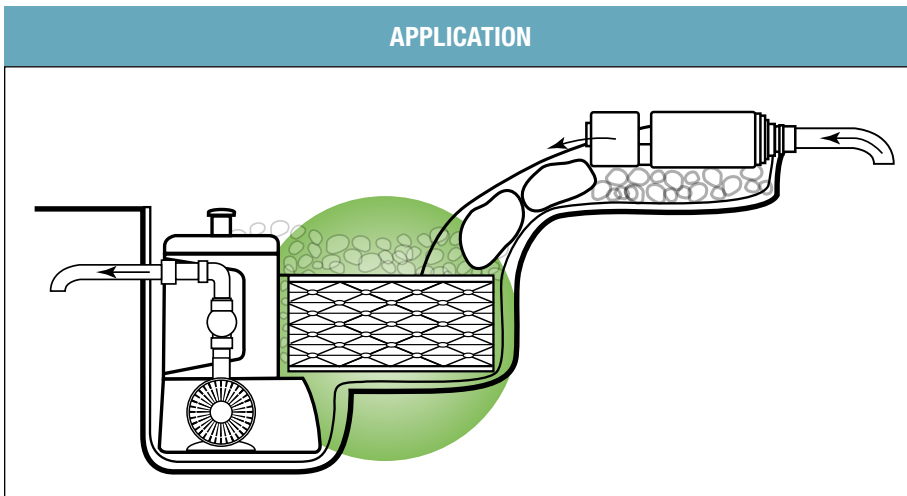

**TAKES ONE MINUTE TO ASSEMBLE!**

AquaBlox are assembled on-site, making transportation and installation extremely efficient

## SNORKEL® AND CENTIPEDE® WETLAND FILTER

Our patented Snorkel® Vault and Centipede® Module were specifically designed to tackle the common issues that plague large scale water features. They are modular in design, allowing builders and designers the flexibility to expand the system to meet their needs. It is highly effective at removing sediment (suspended solids) from ponds, improve water clarity, and reduce the need for costly and invasive dredging. The filter system works on earth bottom and liner membrane ponds and is easily retrofitted onto existing ponds. It also reduces the physical and chemical maintenance that goes along with removing algae.



**Large Snorkel® Vault and Cap**  
#29064

Packaged Weight: 27 lb.



**Large Snorkel® Vault Extension**  
#29068

Packaged Weight: 10 lb.



**Large Centipede® Module**  
#29065

Packaged Weight: 29 lb.

### CONSTRUCTED WETLAND FILTER SYSTEM REQUIREMENTS

POND SIZE (IN SQ. FT.)	FILTER SIZE (AVG 5.5' DEPTH)	NUMBER OF CENTIPEDE MODULES	NUMBER OF SNORKEL WITH EXTENSION	NUMBER OF SMALL AQUABLOX	MIN PUMP FLOW (GPH / LPH)
500	8' x 10'	1	1	16	2,000 / 7,500
1,000	10' x 15'	2	1	32	4,000 / 15,000
2,000	12' x 25'	4	1	64	8,000 / 30,000
5,000	25' x 25'	8	2	128	16,000 / 60,500
7,500	25' x 40'	12	2	192	24,000 / 90,500
10,000	25' x 50'	16	2	256	32,000 / 121,000
15,000	36' x 40'	18	3	288	36,000 / 136,000

### THE WETLAND FILTER

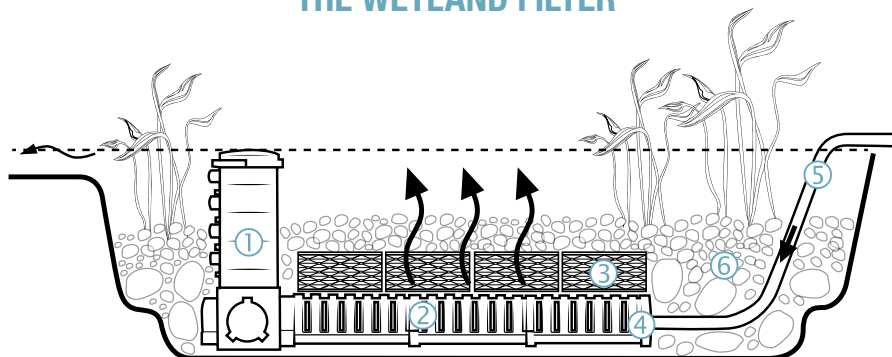

**1. Snorkel® Vault**—Allows pump to be dropped in for easy cleaning and has four ports for Large Centipede Module attachment. Large Snorkel Vault Extensions can be used when creating deeper basins or using the AquascapePRO 10000 or 12-PN pump.

**2. Large Centipede® Module**—Sits at the lowest point in the filter to ensure maximum water distribution and allows for efficient sediment removal during cleaning

**3. AquaBlox®**—Provides water storage

**4. Rubber Coupling**—Creates a water-tight seal

**5. Flex PVC Piping**—Directs water to Centipede Module

**6. Rocks and Gravel**—Naturalizes the wetland area

## IONGEN™ SYSTEM G2

The IonGen™ System G2 effectively removes algae without the use of traditional liquid chemicals. Designed with a microprocessor that sends a signal to its ion-producing probe, the IonGen helps to control string algae throughout the entire water feature. It is simple to install, energy-efficient, and compatible with water containing fish and plants. The IonGen is effective at treating ponds up to 25,000 gallons and comes complete with electronic control panel, outdoor-rated transformer, flow chamber, probe, fittings, probe holder, copper test kit, alkalinity test kit, and owner's manual.

EPA REGISTRATION #83739-1



### IonGen™ System G2

#95027

Packaged Weight: 5 lb.

Packaged Dimensions: 18"L x 4.5"W x 14"H

## Say goodbye to string algae!

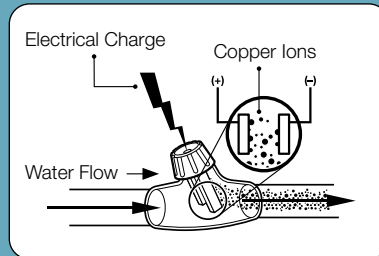

### FEATURES OF THE IONGEN™ SYSTEM G2

1. Weatherproof **control panel**
2. Easy-to-read **digital display**
3. **Indicator** notifies you when the probe needs to be replaced
4. Adjustable **ionization level**
5. Durable **quick-connect electrical connections**
6. Tool-free **probe installation**
7. **Angled probe** helps deflect debris and reduce clogging
8. 2" threaded **inlet and outlet**
9. **Fittings** include: (2) 1", 1.25", 1.5" multi-hose fitting, (2) 2" PVC slip fitting



APPLICATION

**Option 1:** Probe can be installed directly into the water feature plumbing

**Option 2:** Probe can be placed in an area with good water circulation

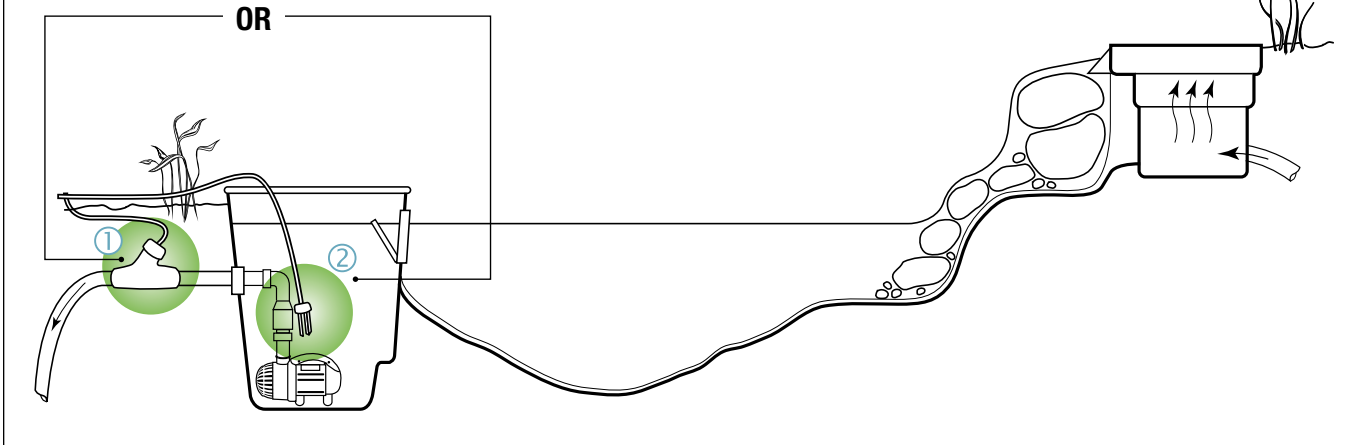

IONGEN™ ACCESSORIES

The following accessories and test kits can be used in conjunction with the IonGen™ System.

**IonGen™ Probe  
for the G2 System**

#95028



- Packaged Weight: .5 lb.  
Packaged Dimensions: 3"L x 2"W x 6"H
- For 2nd generation flow chamber
  - Includes 5 foot quick-connect cable



**IonGen™ G2 Probe Holder**

#95077

- Packaged Weight: 1.5 lb.  
Packaged Dimensions: N/A
- Allows for installation of G2 Probe without flow chamber
  - Can be used in a filter, such as a skimmer or a Pondless® Waterfall Vault
  - Straps onto any pipe or check valve from 1–4 inches in diameter

**Copper Test Kit**

#96020



- Packaged Weight: .2 lb.  
Packaged Dimensions: 4"L x 1.5"W x 5"H
- Measures residual copper
  - 25 tests per kit

**KH/Alkalinity Test Kit**

#96019



- Packaged Weight: .2 lb.  
Packaged Dimensions: 4"L x 1.5"W x 5"H
- Measures KH/alkalinity
  - 60 tests per kit



**Aquascape pumps** are the preferred pond, waterfall, and fountain pumps for hobbyists and professional pond installers alike.

Pumps are the heart of any water feature, continually circulating water and providing aeration to create the basis for a stable ecosystem. Proper pump sizing is critical to the health and function of the water feature, and you want to be sure you've selected the correct pump. To make pump selection easy, visit our website and use our convenient Pond Pump Selection Guide and calculator for selecting the proper pump size.

# CONTROL THE FLOW

*of your waterfall with Aquascape adjustable flow pond pumps!*

Dial up the pump for a more voluminous “party style” waterfall, or dial it down for a quieter, more relaxing waterfall.

With WiFi connectivity and smart control products from Aquascape, you can control pumps from anywhere at any time using your smartphone or tablet! Choose from three adjustable flow pump options to best suit your needs.



The Aquascape Smart Control Receiver is required to run Aquascape adjustable flow pond pumps, allowing you to control your pump at anytime from anywhere. The specially designed receiver makes it easy to connect your pump to the Smart Control App on your smartphone or tablet, allowing for a variety of wireless control functions, including flow adjustment and customized scheduling.



## FEATURES OF THE SMART CONTROL RECEIVER

1. **WiFi pairing light** indicates active connection
2. Integrated control panel clearly displays current flow settings
3. **Flow adjustment controls** allow for quick and easy on-board flow control
4. **On/Off controls** allow the pump to be turned on or off without a remote or device
5. Integrated **hang tag** provides secure mounting option
6. Durable, weather-resistant, injection-molded **housing** is built to last
7. Integrated, weather-proof, **quick-connect fitting** makes setup quick and easy
8. Aquascape **Smart Control App** allows for a variety of wireless control functions, including flow adjustment and customized scheduling



Monitor your energy usage on the Aquascape Smart Control App to make informed decisions about your energy consumption.

## AQUASURGE® POND PUMP

AquaSurge® pond pumps combine energy-efficient performance, high flow rates, and ease of maintenance, making them the perfect choice for pond owners. AquaSurge pumps are ideal for use in pond skimmers and Pondless® Waterfall Vaults. The asynchronous motor technology provides high torque, and trouble-free performance, while the oil-free design prevents pond contamination.



**AquaSurge® 2000  
Pond Pump**

**#91017**

**AquaSurge® 3000  
Pond Pump**

**#91018**

**AquaSurge® 4000  
Pond Pump**

**#91019**

**AquaSurge® 5000  
Pond Pump**

**#91020**



## AQUASURGE® ADJUSTABLE FLOW POND PUMP

AquaSurge® adjustable flow pond pumps include a Smart Control Receiver which makes it easy to connect your pump to your smartphone or tablet, allowing for wireless flow adjustment and customized scheduling.



**AquaSurge®2000–4000  
Adjustable Flow Pond Pump**

**#45009**

**AquaSurge® 4000–8000  
Adjustable Flow Pond Pump**

**#45010**

## AQUASURGE POND PUMP ACCESSORIES

### Smart Control Receiver

**#45038**



**Includes:**

- Conversion plug for converting older model adjustable flow pumps to smart control

**NOTE:** Only compatible with AquaSurge, AquaForce and SLD Adjustable Flow Pond Pumps\*.

\*Not compatible with SLD 5000-9000

### Low Suction Intake Attachment

**#91117**



Packaged Weight: .5 lb.

Packaged Dimensions: 5.75"L x 4.5"W x 5.75"H

Allows pumps to be operated in shallow applications such as the AquaBasin® 45.

**NOTE:** Not compatible with AquaSurge 4000-8000

### Universal Remote for Adjustable Flow Pumps

**#45041**



The optional remote allows wireless control without the use of a smartphone or tablet.

**NOTE:** Only compatible with Aquascape Adjustable Flow Pond Pumps.

### Adjustable Flow Pump Extension Cord

**#45048**

**NEW**



Packaged Weight: 2 lb.

Packaged Dimensions: 14"L x 4.25"W x 4.25"H

Extend adjustable flow pond pumps up to 25 feet from Smart Control Receiver. Allows receiver to be positioned closer to WiFi signal source.

**NOTE:** Only compatible with Aquascape Adjustable Flow Pond Pumps.

## AQUASURGE® POND PUMP

### FEATURES OF THE AQUASURGE POND PUMP



- Compact size** makes it the perfect pump for pond skimmers
- Built-in **cord strain relief** protects the cord from being damaged
- Asynchronous motor** technology makes this pump extremely reliable
- Unique **ceramic shaft** with cooling port prevents the pump from overheating
- Threaded disconnect** allows the pump to be easily removed from the skimmer for maintenance or winterization
- Integrated **rubber feet** prevent noise and vibration
- The **rotational ball output** allows the discharge position to be easily adjusted
- Included **pump stand** allows for vertical positioning
- Convenient **locking knob** for quick and easy cage removal
- Fittings** include (2) 1", 1.25", 1.5" multi-hose fittings, 1.25", 1.5", 2" multi-hose fitting, 1.5", 2" multi-hose fitting, 1.5" rotational ball output, 1.5" female coupler, 1.5" male coupler

MODEL	2000	3000	4000	5000	2000-4000	4000-8000
<b>MAX FLOW RATE</b>	2,193 GPH 8,000 LPH	3,196 GPH 12,000 LPH	3,947 GPH 14,500 LPH	5,284 GPH 20,000 LPH	3,947 GPH 14,500 LPH	7,793 GPH 29,500 LPH
<b>ADJUSTABLE FLOW</b>	—	—	—	—	✓	✓
<b>MAX HEAD HEIGHT</b>	12.5'	15'	18.5'	24'	18.5'	28'
<b>MOTOR TYPE</b>	Asynchronous	Asynchronous	Asynchronous	Asynchronous	Asynchronous	Asynchronous
<b>WATTAGE</b>	160	165	215	360	180 - 215*	500 - 660*
<b>AMPERAGE</b>	1.3	1.4	1.82	3	1.82	5.5
<b>POWER CORD LENGTH</b>	20'	20'	20'	20'	20'	20'
<b>PUMP DISCHARGE DIA</b>	1.5" MPT	1.5" MPT	1.5" MPT	1.5" MPT	1.5" MPT	1.5" MPT
<b>IDEAL PIPE DIA</b>	1.5" - 2"	1.5" - 2"	1.5" - 2"	2"	1.5" - 2"	2" - 3"
<b>PUMP DIMS</b>	12"L x 5.5"W x 7"H	12"L x 5.5"W x 7"H	14"L x 6"W x 7.5"H	14"L x 6"W x 7.5"H	14"L x 6"W x 7.5"H	14"L x 6"W x 7.5"H
<b>RECEIVER</b>	—	—	—	—	✓	✓
<b>WARRANTY</b>	3-Year Limited	3-Year Limited	3-Year Limited	3-Year Limited	3-Year Limited	3-Year Limited
<b>PACKAGED WEIGHT</b>	10 lb.	10.25 lb.	12.75 lb.	14 lb.	13 lb.	16 lb.
<b>PACKAGED DIMS</b>	13.25"L x 9"W x 9"H	13.25"L x 9"W x 9.75"H	15"L x 9.25"W x 10.5"H	15"L x 9.25"W x 11.25"H	15"L x 9.5"W x 10.5"H	15"L x 9.5"W x 12"H

\*Wattage range depending on flow setting.

MODEL	MAX HEAD HEIGHT	APPLICATION HEAD HEIGHT													
		0'	5'	10'	15'	20'	25'	30'	35'	40'	45'	50'	55'		
2000	12.5'	2193	1850	1465	0	GPH									
3000	15'	3196	2700	2350	0	GPH									
4000	18.5'	3947	3750	3350	2250	0	GPH								
5000	24'	5284	5000	4750	3250	1750	0	GPH							
2000-4000	18.5'	3947	3750	3350	2250	0	GPH								
4000-8000	28'	7793	7350	7000	5850	4300	2000	0	GPH						

BEST Operating Zone MAXIMUM Operating Zone

## SLD ADJUSTABLE FLOW POND PUMP

Aquascape SLD adjustable flow pond pumps are professional-grade, asynchronous, solids-handling pumps ideal for use in ponds, Pondless® Waterfalls, and other water feature applications. SLD adjustable flow pond pumps provide superior reliability and solids-handling capability. The included Smart Control Receiver makes it easy to connect to the Smart Control App on your smartphone or tablet, allowing for a variety of wireless control functions, including flow adjustment and customized scheduling.

- Professional-grade, solids-handling pond pump
- Asynchronous motor design provides superior reliability with less maintenance
- Pump flow can be controlled from anywhere with your smartphone or tablet



#45037 shown

**SLD 2000-5000  
Adjustable Flow Pond Pump**

**#45046**

**SLD 4000-7000  
Adjustable Flow Pond Pump**

**#45036**

**SLD 5000-9000  
Adjustable Flow Pond Pump**

**#45037**

Solids-handling capability allows the pump to pass solids, significantly reducing clogging and maintenance.

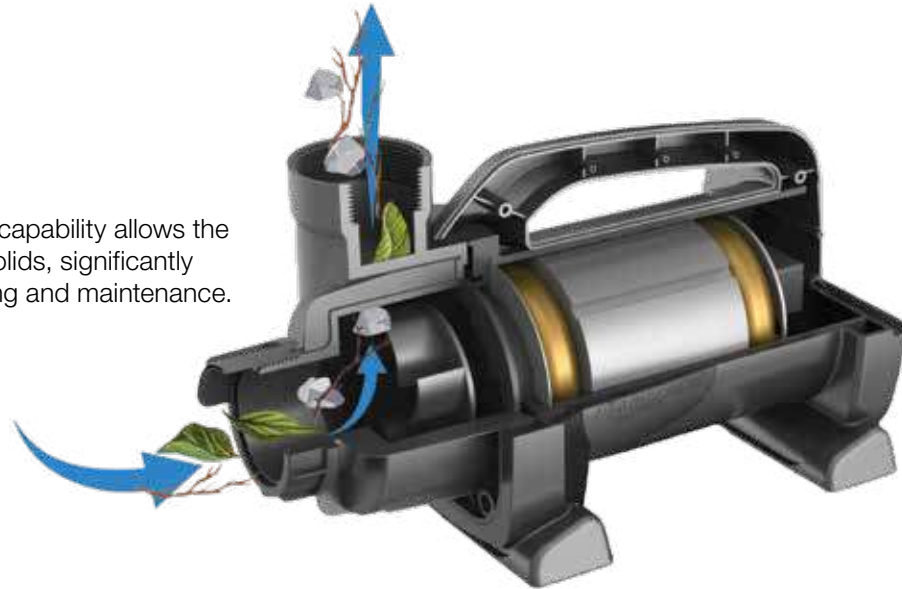

**Universal Remote  
for Adjustable Flow Pumps**

**#45041**



The optional remote allows wireless control without the use of a smartphone or tablet.

**NOTE:** Only compatible with Aquascape adjustable flow pond pumps.

**Adjustable Flow Pump Extension Cord**

**#45048**

**NEW**



Packaged Weight: 2 lb.

Packaged Dimensions: 14"L x 4.25"W x 4.25"H

Extend adjustable flow pond pumps up to 25 feet from Smart Control Receiver. Allows receiver to be positioned closer to WiFi signal source.

**NOTE:** Only compatible with Aquascape adjustable flow pond pumps.

## SLD ADJUSTABLE FLOW POND PUMP

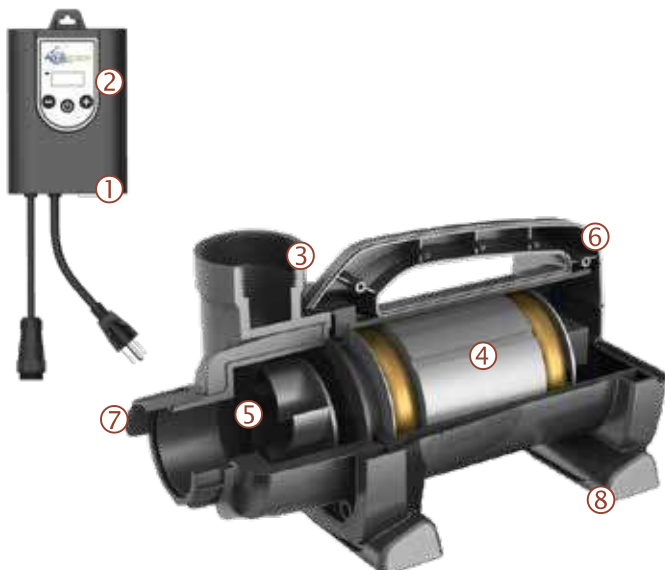

### FEATURES OF THE SLD ADJUSTABLE FLOW POND PUMP

1. **Smart Control Receiver** connects to the Smart Control App, allowing you to control the pump with your smartphone or tablet
2. Integrated **control panel** with digital numeric display and quick and easy flow adjustment
3. **Threaded 2" outlet** allows for quick and easy installation in a variety of applications
4. **Asynchronous motor** technology provides superior reliability and longevity
5. Semi-vortex **impeller** design maximizes water flow and reduces maintenance
6. Durable **pump housing** is built to last and will not corrode or rust
7. **Anti-vortexing shield** prevents the pump from drawing air in low-water situations
8. **Rubber feet** prevent noise and vibration while in use

MODEL	2000-5000	4000-7000	5000-9000
MAX FLOW RATE	6,613 GPH / 25,033 LPH	7,127 GPH / 26,500 LPH	9,574 GPH / 36,000 LPH
ADJUSTABLE FLOW	✓	✓	✓
MAX HEAD HEIGHT	16.7'	25'	33'
MOTOR TYPE	Asynchronous	Asynchronous	Asynchronous
WATTAGE	340	660	1060
AMPERAGE	2.81	6.6	8.9
POWER CORD LENGTH	20'	20'	20'
PUMP DISCHARGE DIA	2" FPT	2" FPT	2" FPT
IDEAL PIPE DIA	2" - 3"	2" - 3"	2" - 3"
PUMP DIMS	13"L x 6.25"W x 7"H	13"L x 6.25"W x 7"H	13"L x 6.25"W x 7"H
APP/WIFI CONNECTED	✓	✓	✓
WARRANTY	3-Year Limited	3-Year Limited	3-Year Limited
PACKAGED WEIGHT	18.75 lb.	17.6 lb.	18 lb.
PACKAGED DIMS	15.25"L x 12"W x 10.75"H	15.25"L x 12"W x 9.5"H	15.25"L x 12"W x 10.75"H

MODEL	MAX HEAD HEIGHT	APPLICATION HEAD HEIGHT																
		0'	5'	10'	15'	20'	25'	30'	35'	40'	45'	50'	55'					
2000-5000	16.7'	5144	3769	2484	1256	GPH												
4000-7000	25'	7126	6148	5044	3802	1957	GPH											
5000-9000	33'	9574	8808	7742	6412	5069	3576	1355	GPH									

BEST Operating Zone MAXIMUM Operating Zone

## PL AND PN SOLIDS-HANDLING POND PUMP

The PL and PN series pumps are known for durability, performance, and value. The direct-drive motor and semi-vortex impeller design enables the pump to efficiently and effectively handle solids, resulting in less maintenance and trouble-free performance. The PL and PN pumps are ideal for use in pond skimmer filters and the Pondless® Waterfall Vault.

**3-PL 3000**  
**Solids-Handling Pond Pump**  
**#29975**

**8-PN 5500**  
**Solids-Handling Pond Pump**  
**#29495**

**5-PL 5000**  
**Solids-Handling Pond Pump**  
**#29976**

**12-PN 10000**  
**Solids-Handling Pond Pump**  
**#30391**

**9-PL 7000**  
**Solids-Handling Pond Pump**  
**#29977**



MODEL	3-PL	5-PL	9-PL	8-PN	12-PN
MAX FLOW RATE	3,000 GPH / 11,000 LPH	5,300 GPH / 20,000 LPH	7,300 GPH / 27,500 LPH	5,548 GPH / 21,000 LPH	10,000 GPH / 37,500 LPH
MAX HEAD HEIGHT	14'	23'	35'	56'	23'
MOTOR TYPE	Direct Drive	Direct Drive	Direct Drive	Direct Drive	Direct Drive
WATTAGE	320	620	1,000	1,000	900
AMPERAGE	3.1	5.6	8.6	9.1	9.1
POWER CORD LENGTH	20'	20'	20'	20'	20'
PUMP DISCHARGE DIA	2"	2"	2"	2"	3"
IDEAL PIPE DIA	1.5" - 2"	2" - 3"	2" - 3"	2" - 3"	3"
PUMP DIMS	12.2"L x 5.6"W x 7.1"H	13.2"L x 5.9"W x 7.3"H	14"L x 5.9"W x 7.3"H	9.3"L x 6.4"W x 15"H	11.7"L x 7.7"W x 15.1"H
WARRANTY	2-Year Limited	2-Year Limited	2-Year Limited	2-Year Limited	2-Year Limited
PACKAGED WEIGHT	16 lb.	19 lb.	23 lb.	24 lb.	36 lb.
PACKAGED DIMS	13"L x 9.75"W x 9.5"H	15"L x 9.75"W x 9.5"H	15"L x 9.75"W x 9.5"H	17.25"L x 10.25"W x 9"H	12.5"L x 9"W x 17.75"H

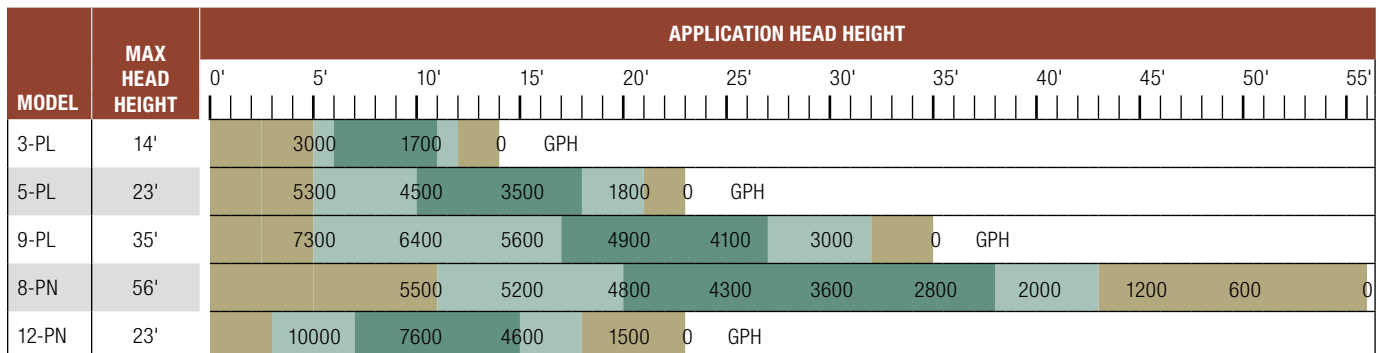

BEST Operating Zone
  MAXIMUM Operating Zone
  DO NOT Operate Zone



# EXT POND PUMPS



Aquascape external or in-line pumps are ideal for water feature applications requiring high flow combined with high efficiency in a non-submersible style pump. EXT pond pumps have an oil-free design and the low RPM, fan-cooled motor provides quiet operation and a long life.



**EXT 12000  
Pond Pump**

**#45049**

**EXT 18000  
Pond Pump**

**#45050**



**EXT 12000-3P  
Pond Pump**

**#45051**

**EXT 18000-3P  
Pond Pump**

**#45052**



Features a 5-year limited warranty.



**EXT Pump Plumbing Kit**

**#48027**

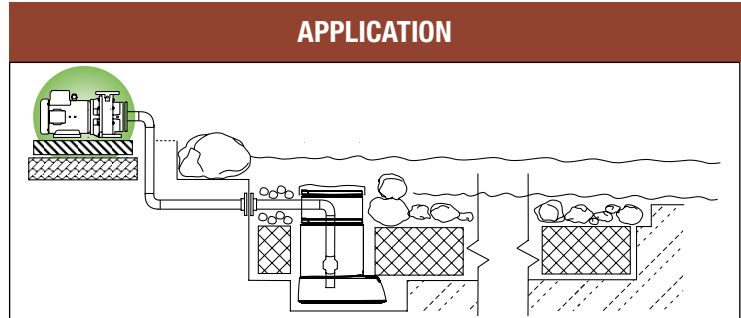

MODEL	12000	12000-3P	18000	18000-3P
MAX FLOW RATE	12,500 GPH / 47,318 LPH	12,500 GPH / 47,318 LPH	18,400 GPH / 69,652 LPH	18,400 GPH / 69,652 LPH
MAX HEAD HEIGHT	21'	21'	45'	45'
MOTOR TYPE/HP	143JM / 3/4 HP	143JM / 1 HP	184JM / 3 HP	184JM / 3 HP
WATTAGE	1,100	736	3,300	1,932
MAX CURRENT AMPS @	115V - 10 A / 230V - 5 A	230V - 3.2 A / 460V - 1.6 A	115V - 30 A / 230V - 15 A	230V - 8.4 A / 460V - 4.2 A
POWER CORD LENGTH	10'	N/A	N/A	N/A
PUMP DISCHARGE DIA	2"	2"	2"	2"
PUMP INLET DIA	3"	3"	3"	3"
IDEAL PIPE DIA	3"	3"	3"	3"
PHASE	Single	3-Phase	Single	3-Phase
PUMP DIMS	19.3"L x 11.9"W x 11.75"H	19.3"L x 11.9"W x 11.75"H	21.15"L x 12.9"W x 11.75"H	21.9"L x 12.65" W x 11.75"H
PACKAGED WEIGHT	114 lb.	115 lb.	114 lb.	115 lb.
PACKAGED DIMS	30"L x 17.5"W x 18"H	30"L x 17.5"W x 18"H	30"L x 17.5"W x 18"H	30"L x 17.5"W x 18"H

MODEL	MAX HEAD HEIGHT	APPLICATION HEAD HEIGHT											
		0'	5'	10'	15'	20'	25'	30'	35'	40'	45'	50'	
12000	21'	12000	11500	9916	7760	4245	0	GPH					
12000-3P	21'	12000	11500	9916	7760	4245	0	GPH					
18000	45'	18000	17000	16500	15660	14332	13000	11700	9832	7720	3600	0	GPH
18000-3P	45'	18000	17000	16500	15660	14332	13000	11700	9832	7720	3600	0	GPH

BEST Operating Zone
MAXIMUM Operating Zone
DO NOT Operate Zone

## ECOWAVE® POND PUMP

EcoWave® pond pumps are magnetically-driven (mag-drive) pond and waterfall pumps developed to provide high flow rates. The internal, smart mag-drive motor technology and vortex style impeller allows these pumps to push an incredible amount of water with an electrical efficiency unmatched by other pumps with similar flow rates. EcoWave pond pumps are ideal for use in pond skimmers and Pondless® Waterfall Vault applications with lower head heights. Made for continuous use, EcoWave pumps will not corrode or rust. They are complete with a compact and oil-free design that prevents pond contamination.



#91133 shown

EcoWave® 2000 Pond Pump

#91131

EcoWave® 3000 Pond Pump

#91132

EcoWave® 4000 Pond Pump

#91133

EcoWave® 5000 Pond Pump

#91134



### FEATURES OF THE ECOWAVE POND PUMP

1. Protective **filter screen** reduces maintenance and prevents damage to the pump
2. Durable **thermoplastic housing** will not corrode or rust
3. High-flow vortex **impeller** maximizes water flow
4. Smart **mag-drive motor** provides significant electrical cost savings
5. Internal **PC board** provides high flow rates with unmatched electrical efficiency
6. Built-in **overload sensor** prevents pump damage
7. **Rubber feet** prevent noise and vibration
8. **Fittings** include: (2) 1", 1.25", 1.5" multi-hose fittings, 1.5" rotational ball output, 2" FPT x 1.5" MPT, 1.5" female coupler

## ECOWAVE® POND PUMP

MODEL	2000	3000	4000	5000
MAX FLOW RATE	2,020 GPH / 7,500 LPH	2,960 GPH / 11,000 LPH	4,000 GPH / 15,000 LPH	5,000 GPH / 18,500 LPH
MAX HEAD HEIGHT	14.4'	17.5'	20'	21'
MOTOR TYPE	Mag-Drive	Mag-Drive	Mag-Drive	Mag-Drive
WATTAGE	65	90	130	150
AMPERAGE	0.54	.75	1.08	1.25
POWER CORD LENGTH	20'	20'	20'	20'
PUMP DISCHARGE DIA	2" MPT	2" MPT	2" MPT	2" MPT
IDEAL PIPE DIA	1.5" - 2"	1.5" - 2"	1.5" - 2"	2"
PUMP DIMS	11"L x 5.75"W x 7.5"H	11"L x 5.75"W x 7.5"H	11"L x 5.75"W x 7.5"H	11"L x 5.75"W x 7.5"H
WARRANTY	3-Year Limited	3-Year Limited	3-Year Limited	3-Year Limited
PACKAGED WEIGHT	10.25 lb.	11.5 lb.	13 lb.	14 lb.
PACKAGED DIMS	13"L x 11"W x 10.5"H	13"L x 11"W x 11.75"H	13"L x 11"W x 13"H	13"L x 11"W x 14"H

MODEL	MAX HEAD HEIGHT	APPLICATION HEAD HEIGHT															
		0'	2.5'	5'	7.5'	10'	12.5'	15'	17.5'	20'	22.5'	25'	27.5'	30'	32.5'	35'	37.5'
2000	14.4'	2020	1350	860	650	400	150	0	GPH								
2000	17.5'	2960	2150	1470	1100	850	550	300	0	GPH							
4000	20'	4000	2950	2210	1650	1250	1000	750	400	0	GPH						
5000	21'	5000	4050	3205	2450	1850	1450	1100	750	300	0	GPH					

 **BEST** Operating Zone     **MAXIMUM** Operating Zone

## ECOWAVE® POND PUMP ATTACHMENTS



**Low Suction Intake Attachment**

**#91117**

Packaged Weight: .5 lb.  
Packaged Dimensions: 5.75"L x 4.5"W x 5.75"H

Allows pumps to be operated in shallow applications such as the AquaBasin® 45. Compatible with the EcoWave® 2000 & 3000.

**NOTE:** Not compatible with EcoWave 4000 and 5000.



**Check Valve Adapter for EcoWave® Pond Pump - 2"**

**#88058**

Packaged Weight: .5 lb.  
Packaged Dimensions: 3.75"L x 3.75"W x 4"H

The Check Valve Adapter for EcoWave Pump - 2", is designed to make it quick and easy to connect Aquascape EcoWave pumps to the Dual Union Check Valve 2.0 (#48026).

**NOTE:** Compatible with EcoWave Pump models 2000-5000.

## AQUAFORCE® SOLIDS-HANDLING POND PUMP

AquaForce® asynchronous, solids-handling waterfall and filter pumps combine energy-efficient performance, high flow rates, and ease of maintenance, making this pump the ideal choice for discerning pond owners. The protective pre-filter cage allows the pump to be placed directly into the pond. The asynchronous motor technology provides high torque, trouble-free performance and is easy to maintain. The AquaForce can also be used as a de-icer pump during cold weather months. For more information, see page 104.



#91012 shown



**AquaForce® 1000**  
Solids-Handling Pond Pump

**#91011**

**AquaForce® 1800**  
Solids-Handling Pond Pump

**#91112**

**AquaForce® 2700**  
Solids-Handling Pond Pump

**#91012**

**AquaForce® 3600**  
Solids-Handling Pond Pump

**#91113**

**AquaForce® 5200**  
Solids-Handling Pond Pump

**#91013**

## AQUAFORCE® ADJUSTABLE FLOW SOLIDS-HANDLING POND PUMP

AquaForce® Adjustable Flow Solids-Handling Pond Pumps now include a Smart Control Receiver, which makes it easy to connect to the Smart Control App on your smartphone or tablet, allowing for wireless flow adjustment, customized scheduling, and more.



**AquaForce® 4000–8000 Adjustable Flow**  
Solids-Handling Pond Pump

**#91104**



## ADJUSTABLE FLOW POND PUMP ACCESSORIES



**Smart Control Receiver**

**#45038**

**Includes:**

- Conversion plug for converting older model adjustable flow pumps to smart control

**NOTE:** Only compatible with AquaSurge, AquaForce and SLD adjustable flow pond pumps\*.

\*Not compatible with SLD 5000-9000



**Universal Remote**  
for Adjustable Flow Pumps

**#45041**

The optional remote allows wireless control without the use of a smartphone or tablet.

**NOTE:** Only compatible with Aquascape adjustable flow pond pumps.



**NEW**

**Adjustable Flow Pump Extension Cord**

**#45048**

Packaged Weight: 2 lb.

Packaged Dimensions: 14"L x 4.25"W x 4.25"H

Extend adjustable flow pond pumps up to 25 feet from Smart Control Receiver. Allows receiver to be positioned closer to WiFi signal source.

**NOTE:** Only compatible with Aquascape adjustable flow pond pumps.

# AQUAFORCE® SOLIDS-HANDLING POND PUMP



## FEATURES OF THE AQUAFORCE SOLIDS-HANDLING POND PUMP

1. Protective **pump cage** with large cage openings reduce maintenance and prevent the pump from being clogged or damaged
2. **Asynchronous motor** technology makes this pump extremely reliable and powerful
3. The simple and secure **threaded disconnect** allows the pump to be easily removed from the pond without removing hose clamps or plumbing assembly
4. The wide, **flat shape** of the pump cage makes it stable and easy to place in the pond
5. The **rotational ball output** allows the pump discharge position to be easily adjusted
6. **Fittings** include (2) 1", 1.25", 1.5" multi-hose fittings, 1.25", 1.5", 2" multi-hose fitting, 1.5", 2" multi-hose fitting, 1.5" rotational ball output, 1.5" female coupler, 1.5" male coupler

MODEL	1000	1800	2700	3600	5200	4000-8000
MAX FLOW RATE	1,070 GPH 4,000 LPH	2,149 GPH 8,000 LPH	2,695 GPH 10,000 LPH	3,868 GPH 14,500 LPH	5,284 GPH 20,000 LPH	7,793 GPH 29,500 LPH
ADJUSTABLE FLOW	—	—	—	—	—	✓
MAX HEAD HEIGHT	10'	16.5'	14'	18'	24'	28'
MOTOR TYPE	Asynchronous	Asynchronous	Asynchronous	Asynchronous	Asynchronous	Asynchronous
WATTAGE	55	160	147	215	360	500-660*
AMPERAGE	0.51	1.33	1.25	1.8	3	5.5
POWER CORD LENGTH	25'	25'	25'	25'	25'	20'
PUMP DISCHARGE DIA	1.5" MPT	1.5" MPT	1.5" MPT	1.5" MPT	1.5" MPT	1.5" MPT
IDEAL PIPE DIA	1" - 1.5"	1" - 1.5"	1.5" - 2"	1.5" - 2"	2"	2" - 3"
PUMP DIMS	14"L x 14"W x 6.5"H	14"L x 14"W x 6.5"H	14"L x 14"W x 6.5"H	14"L x 14"W x 6.5"H	14"L x 14"W x 6.5"H	14"L x 14"W x 6.5"H
RECEIVER	—	—	—	—	—	✓
WARRANTY	3-Year Limited	3-Year Limited	3-Year Limited	3-Year Limited	3-Year Limited	3-Year Limited
PACKAGED WEIGHT	11 lb.	12.25 lb.	12 lb.	14.5 lb.	14.5 lb.	18.5 lb.
PACKAGED DIMS	14.25"L x 9"W x 14.75"H	14.25"L x 9"W x 15.25"H	14.25"L x 9"W x 15.75"H	14"L x 9"W x 16.25"H	14"L x 9"W x 16.75"H	14"L x 9"W x 18.75"H

\* Wattage range depending on flow setting.

MODEL	MAX HEAD HEIGHT	APPLICATION HEAD HEIGHT												
		0'	5'	10'	15'	20'	25'	30'	35'	40'	45'	50'	55'	
1000	10'	1070	850	0	GPH									
1800	16.5'	2149	1806	1320	260	0	GPH							
2700	14'	2695	2425	1840	0	GPH								
3600	18'	3868	3613	3254	2100	0	GPH							
5200	24'	5284	5116	4250	3186	1500	0	GPH						
4000-8000	28'	7794	7150	6440	5320	3950	1800	0	GPH					

BEST Operating Zone MAXIMUM Operating Zone

## AQUAJET® POND PUMP

AquaJet® pond pumps create a stunning water fountain with the choice of three included fountain heads and an integrated diverter valve to supply water to a small waterfall, external filters, or spitting ornaments. These mag-drive pumps are extremely energy-efficient, resulting in considerable annual energy savings. They're easy to maintain and include a durable pre-filter cage design that prevents clogging and reduces pump maintenance.



#91016 shown

**AquaJet® 600 Pond Pump**  
#91014

**AquaJet® 1300 Pond Pump**  
#91015

**AquaJet® 2000 Pond Pump**  
#91016

MODEL	MAX HEAD HEIGHT	APPLICATION HEAD HEIGHT					
		0'	5'	10'	15'	20'	25'
600	7.5'	525	300	0	GPH		
1300	13.5'	1350	1050	625	0	GPH	
2000	20'	2000	1800	1525	1075	0	GPH

BEST Operating Zone MAXIMUM Operating Zone



### FEATURES OF THE AQUAJET® POND PUMP

1. Adjustable **riser stem** allows for easy height adjustment from 10 to 20 inches
2. Adjustable **diverter** and flow control
3. Rotational **riser stem fitting** allows for simple leveling of fountain heads
4. Protective **pump cage** prevents debris from clogging or damaging pump, thereby reducing maintenance
5. **Mag-drive motor** technology makes this pump energy-efficient and simple to maintain
6. **Fittings** include AquaJet riser stems, multi-hose fitting, diverter valve, and foaming jet, waterbell, and daisy fountain heads

MODEL	600	1300	2000
POND SIZE RECOMMENDATION	1,200 gal.	1,300 gal.	2,000 gal.
MAX FOUNTAIN HEIGHT (DAISY FOUNTAIN)	Up to 47"	Up to 62"	Up to 65"
MOTOR TYPE	Mag-drive	Mag-drive	Mag-drive
WATTAGE	33	110	250
AMPERAGE	0.55	1.00	2.60
POWER CORD LENGTH	25'	25'	25'
PUMP DISCHARGE DIA ON DIVERTER	½", ¾"	½", ¾"	½", ¾", 1"
DIMS	12"L x 12"W x 6"H	12"L x 12"W x 6"H	12"L x 12"W x 6"H
WARRANTY	3-Year Limited	3-Year Limited	3-Year Limited
PACKAGED WEIGHT	6.5 lb.	9 lb.	9.5 lb.
PACKAGED DIMS	13"L x 9"W x 14"H	13.25"L x 8.75"W x 15"H	13.25"L x 9"W x 15.75"H

## POND POWERHEAD

The Aquascape Pond Powerhead is an innovative low voltage circulation pump designed to create water movement in ponds. Set the powerhead directly in the pond or disguise it using rocks or other materials. Great for solving problems with stagnant water, the Pond Powerhead provides water movement, surface agitation, aeration, and circulation. Its small compact design makes it easy to install in a new or existing water feature and requires no pipe or plumbing. The energy-efficient, low voltage 40-Watt motor can be powered by a standard outdoor 12-volt low voltage transformer (sold separately, see page 55). It includes 25 feet quick-connect cable and can be used alone or with additional Pond Powerheads to maximize circulation in larger water features.



Requires Low-Voltage Transformer  
(Sold Separately)



### Pond Powerhead

#91142

Packaged Weight: 7.75 lb.  
Dimensions: 9.75"L x 5.75"W x 5.75"H



Compatible with Aquascape quick-connect splitters and extension cables (see page 74)

### WIRING DIAGRAM

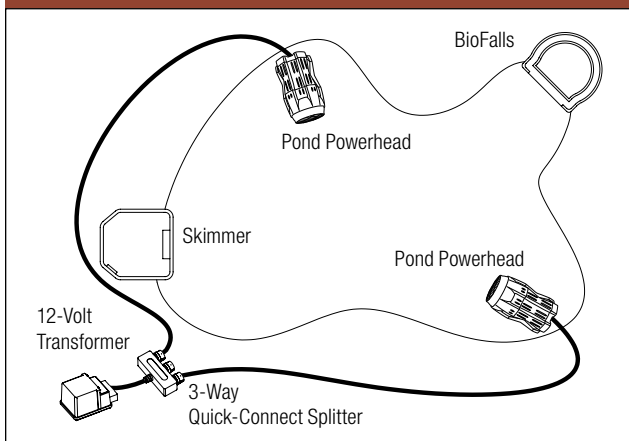

### FEATURES OF THE POND POWERHEAD

1. **Adjustable head** allows for directional flow control
2. **Propeller** maximizes water flow
3. Energy-efficient, **12-volt motor** design
4. **Durable construction** ensures years of trouble-free use

### APPLICATION

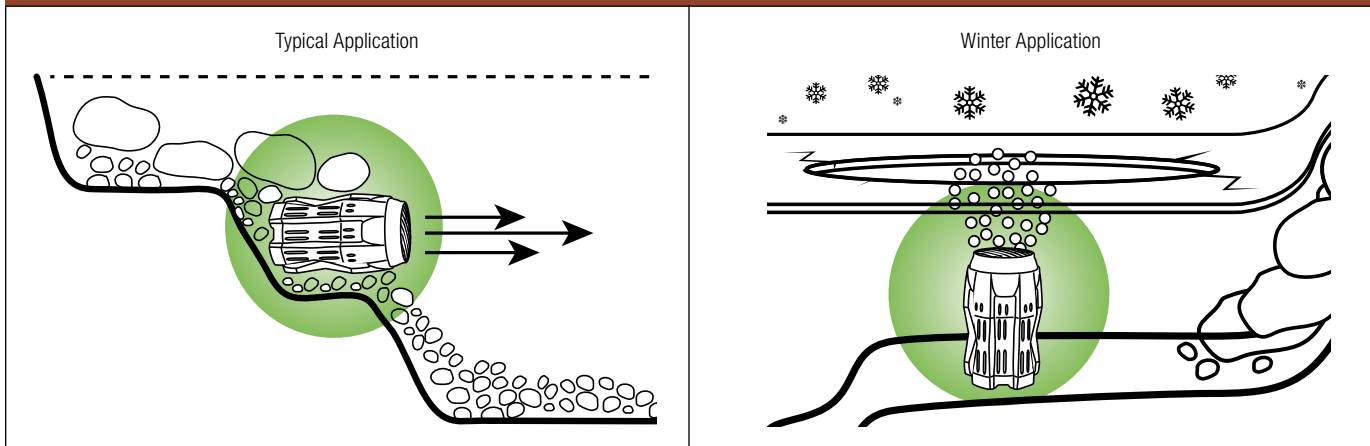

## ULTRA WATER PUMP

Ultra water pumps are the complete solution for decorative fountains and spitters. These versatile pumps include a three-way or single valve and multi-size hose connection, making them adaptable to almost any pipe or tubing size. The magnetically-driven motor technology is easy to maintain and extremely energy-efficient.



Ultra 400  
Water Pump  
#91005

Ultra 1100  
Water Pump  
#91008

Ultra 550  
Water Pump  
#91006

Ultra 1500  
Water Pump  
#91009

Ultra 800  
Water Pump  
#91007

Ultra 2000  
Water Pump  
#91010



Convenient locking knob for quick and easy cage removal.

### FEATURES OF THE ULTRA WATER PUMP

1. Protective **pump strainer cover and sponge filter** prevent debris from damaging pump, thereby reducing maintenance and prolonging pump life
2. **Mag-drive motor** technology makes this pump energy-efficient and simple to maintain
3. The wide, **flat base and rubber feet** make the pump stable and reduce vibration
4. Convenient **locking knob** for quick and easy cage removal
5. **Fittings included with 400/550/800:** 3/4", 1", 1.25" multi-hose adapter, 1/2" MPT coupling, FPT 90° elbow 1/2", 1/2" valve
6. **Fittings included with 1100/1500/2000:** 3/4", 1", 1.25" multi-hose adapter, 1", 1.25", 1.5" multi-hose adapter, 3/4" MPT coupling, FPT 90° elbow 3/4", 3/4" 3-way valve



OR



Included fittings integrate seamlessly into Aquascape AquaBasins.





## ULTRA WATER PUMP

MODEL	400	550	800	1100	1500	2000
MAX FLOW RATE	370 GPH / 1,000 LPH	528 GPH / 1,500 LPH	793 GPH / 3,000 LPH	1,110 GPH / 4,000 LPH	1,480 GPH / 5,500 LPH	1,982 GPH / 7,500 LPH
MAX HEAD HEIGHT	7.5'	8'	9'	12'	16.5'	20'
MOTOR TYPE	Mag-drive	Mag-drive	Mag-drive	Mag-drive	Mag-drive	Mag-drive
WATTAGE	24	33	58	92	153	250
AMPERAGE	0.40	0.55	0.80	0.85	1.46	2.60
CORD LENGTH	12'	12'	25'	25'	25'	25'
DISCHARGE DIA	½", ¾", 1", 1.25"	½", ¾", 1", 1.25"	½", ¾", 1", 1.25"	¾", 1", 1.25"	¾", 1", 1.25"	¾", 1", 1.25"
IDEAL PIPE DIA	½" - 1"	½" - 1"	½" - 1"	¾" - 1.25"	¾" - 1.25"	¾" - 1.25"
PUMP DIMS	5.5"L x 4"W x 3.5"H	6"L x 4"W x 4"H	6"L x 4"W x 4"H	9"L x 5"W x 6"H	9.5"L x 6"W x 7"H	9.5"L x 6"W x 7"H
WARRANTY	3-Year Limited	3-Year Limited	3-Year Limited	3-Year Limited	3-Year Limited	3-Year Limited
PACKAGED WEIGHT	2.5 lb.	3 lb.	4.5 lb.	5.25 lb.	8 lb.	9 lb.
PACKAGED DIMS	9"L x 5"W x 5"H	9"L x 5.25"W x 5.25"H	9"L x 6.5"W x 6"H	9.5"L x 6.75"W x 7"H	10.5"L x 8"W x 8"H	10.5"L x 8"W x 9"H

MODEL	MAX HEAD HEIGHT	APPLICATION HEAD HEIGHT																							
		0'	2.5'	5'	7.5'	10'	12.5'	15'	17.5'	20'	22.5'	25'	27.5'	30'	32.5'	35'	37.5'	40'							
400	7.5'	370	300	200	0	GPH																			
550	8'	528	425	300	75	0	GPH																		
800	9'	793	675	500	275	0	GPH																		
1100	12'	1110	1000	800	600	300	0	GPH																	
1500	16.5'	1480	1350	1200	1050	825	575	200	0	GPH															
2000	20'	1985	1875	1750	1600	1375	1125	800	450	0	GPH														

 BEST Operating Zone

## ULTRA WATER PUMP FOUNTAIN HEAD KITS



**Small Ultra Pump Fountain Head Kit**  
Ideal for Ultra 400, 550, and 800

**#91045**

Packaged Weight: .5 lb.  
Packaged Dimensions: 5.5"L x 3.5"W x 7.25"H



**Large Ultra Pump Fountain Head Kit**  
Ideal for Ultra 1100, 1500, and 2000

**#91046**

Packaged Weight: .5 lb.  
Packaged Dimensions: 6"L x 3"W x 9"H

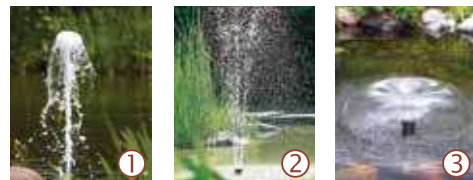

**INCLUDED FOUNTAIN HEADS**

1. Foaming Jet Fountain
2. Daisy Fountain
3. Waterbell Fountain

## STATUARY WATER PUMP

These high quality, magnetically-driven water pumps are ideal for supplying water to run small fountains, container water gardens, and decorative spitters. The combination of energy efficiency, mag-drive performance, water flow, and ease of maintenance makes this pump the ideal choice for discerning water feature owners. The pre-filter prevents clogging and reduces pump maintenance, while the oil-free design prevents contamination.



70 GPH Water Pump  
#91023

90 GPH Water Pump  
#91024

180 GPH Water Pump  
#91025

320 GPH Water Pump  
#91026



#91025 shown

### FEATURES OF THE STATUARY PUMP

1. **Mag-drive motor** technology makes this pump energy-efficient and simple to maintain
2. Included **flow control** allows you to create a customized water flow
3. The wide, **flat base** of the pump makes it stable and easy to place in the pond or fountain
4. Protective pump **pre-filter** prevents debris from clogging or damaging pump, reducing maintenance
5. **Intake** on the bottom of the pump prevents the pump from running dry or drawing air in shallow applications

MODEL	70	90	180	320
MAX FLOW RATE	70 GPH / 250 LPH	90 GPH / 300 LPH	180 GPH / 650 LPH	320 GPH / 1,200 LPH
MAX HEAD HEIGHT	2'	3'	4'	5.5'
MOTOR TYPE	Mag-drive	Mag-drive	Mag-drive	Mag-drive
WATTAGE	3.0	4.3	9.3	17.6
AMPERAGE	0.037	0.061	0.175	0.339
POWER CORD LENGTH	6'	6'	6'	6'
DISCHARGE HOSE DIA	1/2", 5/8"	1/2", 5/8"	1/2", 5/8"	1/2", 5/8"
PUMP DIMS	2"L x 1.5"W x 1.25"H	2.5"L x 1.75"W x 2"H	3"L x 2.5"W x 2"H	4"L x 3.25"W x 2.5"H
WARRANTY	3-Year Limited	3-Year Limited	3-Year Limited	3-Year Limited
PACKAGED WEIGHT	.75 lb.	.75 lb.	1.5 lb.	1.25 lb.
PACKAGED DIMS	4"L x 4"W x 2.75"H	4.25"L x 4"W x 3.25"H	4"L x 4"W x 4"H	4"L x 4"W x 4.75"H

## PUMP CLEANER MAINTENANCE SOLUTION

The Aquascape Pump Cleaner Maintenance Solution quickly cleans and lubricates pond, waterfall, and fountain pumps to keep them operating properly. This maintenance solution uses cutting-edge cleaning compounds to remove scale and biofilm to restore the pump.



### Pump Cleaner Maintenance Solution

8 oz.

**#91143**

Packaged Weight: .75 lb.

### APPLICATION

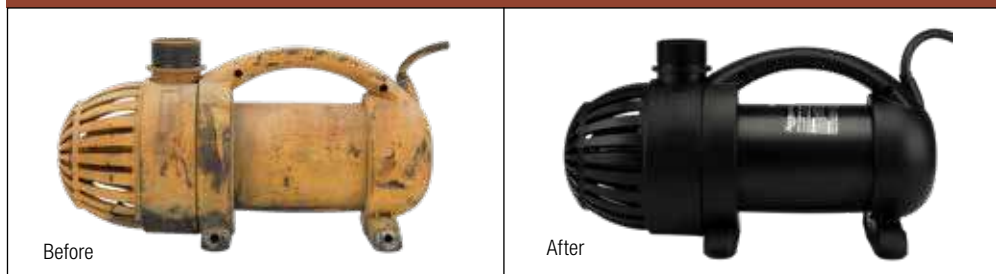

## CLEANOUT PUMP AND DISCHARGE HOSE

The Aquascape Cleanout Pump is great for pond cleanouts and installation wash-downs. The Cleanout Pump can handle 4,200 gallons an hour for quick, easy pump-outs. It can pump water down to a quarter-inch off the bottom of the pond. The heavy-duty Cleanout Pump Discharge Hose is engineered for flexibility and optimal flow. The swivel cuff fitting prevents kinking or tangling for easy movement around the water feature.



### Cleanout Pump

**#45033**

Packaged Weight: 26 lb.  
Packaged Dimensions: 10"L x 8.25"W x 14"H



### Cleanout Pump Discharge Hose 50'

**#48019**

Packaged Weight: 14.75 lb.  
Packaged Dimensions: 22.5"L x 22.5"W x 9"H



**Pond aerators** supply dissolved oxygen directly to ponds, helping all biological processes and resulting in healthier fish and plants. Proper aeration creates a stable pond environment by keeping water healthy, clean, and clear. Aeration can also be used during cold winter months to keep a hole open in the ice formed at the surface of the pond, allowing for the exchange of gases.

## 2-OUTLET AND 4-OUTLET POND AERATION KITS

Aquascape 2-Outlet and 4-Outlet Pond Aeration Kits provide efficient aeration for ponds and water features up to 3,500 gallons, resulting in a healthier ecosystem and happier fish and plants. These aerators are extremely energy-efficient and operate quietly. They are simple to use and easy to maintain. The durable outer housing prevents damage, and the kits include a winter resistant air line, check valves, and air discs.



**2-Outlet Pond Aeration Kit**  
#75000



**4-Outlet Pond Aeration Kit**  
#75001



**Pond Aerator Aeration Disc**  
#75005

Packaged Weight: .5 lb.  
Packaged Dimensions: 5"L x 9"W x 1"H



#75001 shown

### FEATURES OF THE POND AERATION KIT

1. Strong **outer housing** protects the pump from becoming damaged
2. The wide, **flat base** of the pump makes it stable and easy to place
3. The integrated **rubber feet** minimize noise and vibration while maximizing stability
4. Durable **aeration discs** provide ideal air flow

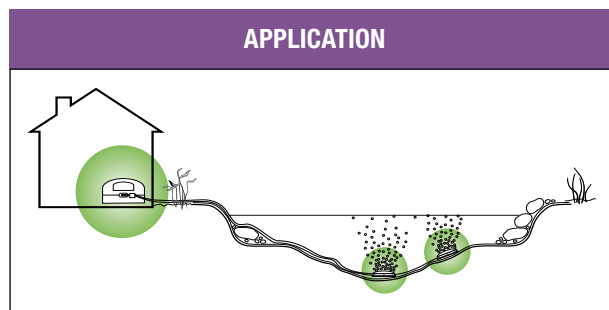

MODEL	2-OUTLET POND AERATION KIT	4-OUTLET POND AERATION KIT
POND SIZE	Up to 2,000 gal.	Up to 3,000 gal.
MAX RECOMMENDED POND DEPTH	8.5'	9'
MAX AIR FLOW RATE (LOADED)	0.28 CFM (8 L/min.)	0.49 CFM (14 L/min.)
MAX AIR DEPTH (LOADED)	3.70 psi (0.26 kgf/cm <sup>2</sup> )	3.98 psi (0.28 kgf/cm <sup>2</sup> )
NUMBER OF AERATION DISCS	2	4
WATTAGE	6	11
POWER CORD LENGTH	6'	6'
AIRLINE LENGTH	(2) 25' Rolls 3/16" Silicone	(4) 25' Rolls 3/16" Silicone
PUMP DIMS	5.25"L x 4.75"W x 3.5"H	7.75"L x 7.25"W x 6.25"H
WARRANTY	3-Year Limited	3-Year Limited
PACKAGED WEIGHT	3.5 lb.	6.25 lb.
PACKAGED DIMS	15.5"L x 4"W x 12"H	17.75"L x 5.5"W x 11.75"H

## PRO AIR POND AERATION KITS

The Aquascape Pro Air 20 and 60 Pond Aeration Kits are the ideal solution for aerating ponds and water features. The complete kit provides everything needed to supply dissolved oxygen directly to pond water, helping all biological processes and ensuring healthier water, fish, and plants.



**Pro Air 20 Pond Aeration Kit**  
**#61009**



**Pro Air 60 Pond Aeration Kit**  
**#61008**



### FEATURES OF THE PRO AIR POND AERATION KIT

1. Outdoor-rated **compressor** with heavy-duty metal housing stands up to the elements
2. 2-way compressor **manifold** allows for easy airflow adjustment
3. Integrated **rubber feet** minimize noise and vibration
4. 3/8" braided **tubing** with pre-installed check valve is freeze resistant and built to last
5. Interior weighted **ballast** keeps the diffuser at the bottom of the pond
6. Self-cleaning **rubber membrane** expands to clear clogging debris

MODEL	PRO AIR 20 KIT	PRO AIR 60 KIT
POND SIZE	Up to 5,000 gal.	Up to 15,000 gal.
MAX RECOMMENDED POND DEPTH	6.5'	11.5'
MAX AIR FLOW RATE (LOADED)	0.71 CFM (20 L/min.)	2.1 CFM (60 L/min.)
MAX AIR DEPTH (LOADED)	2.90 psi (0.20 kgf/cm <sup>2</sup> )	5.08 psi (0.36 kgf/cm <sup>2</sup> )
NUMBER OF OUTLETS	1	2
NUMBER OF DIFFUSERS	1	2
WATTAGE	15	45
POWER CORD LENGTH	6'	6'
AIRLINE LENGTH	(1) 30' Roll 3/8" Braided Vinyl	(2) 30' Roll 3/8" Braided Vinyl
PUMP DIMS	6"L x 5.5"W x 4.25"H	7.75"L x 7.25"W x 4"H
AERATION DIFFUSER DIMS	10"L x 4"H	10"L x 4"H
CHECK VALVE (PRE-INSTALLED)	✓	✓
WARRANTY	3-Year Limited	3-Year Limited
PACKAGED WEIGHT	11.5 lb.	22 lb.
PACKAGED DIMS	12"L x 11"W x 10"H	14.25"L x 12.75"W x 9"H

## PRO AIR POND AERATION ACCESSORIES



### Weighted Aeration Tubing

3/8" x 25'

#61011

Packaged Weight: 7.3 lb.  
Packaged Dimensions: 13"L x 13"W x 4.75"H

### Weighted Aeration Tubing

3/8" x 100'

#61014

Packaged Weight: 32 lb.  
Packaged Dimensions: 18"L x 14"W x 9"H

- Self-sinking air supply tubing keeps pond airline tubing at the bottom of the pond
- Improves water feature appearance and reduces installation time
- Constructed of thick-walled, puncture-resistant, extruded PVC
- Non-kinking and flexible
- UV resistant, lead free, and fish safe



### 10" Rubber Membrane Aeration Diffuser

#61010

Packaged Weight: 2.75 lb.  
Packaged Dimensions: 11.75"L x 4"W x 4"H



### Pro Air 20 Aeration Compressor

#61017

Packaged Weight: 5.75 lb.  
Packaged Dimensions: 8.75"L x 7.5"W x 7"H



### Pro Air 60 Aeration Compressor

#61016

Packaged Weight: 11.5 lb.  
Packaged Dimensions: 9.5"L x 7.75"W x 8.25"H



### 2-Way Aeration Compressor Manifold

#61012

Packaged Weight: .25 lb.

**NOTE:** Only for use with Pro Air 60 Aeration Compressor



### Pond Aerator Pro Check Valve

#61003

Packaged Weight: .2 lb.  
Packaged Dimensions: 1.5"L x 1"W x 1"H



### Barbed Coupling 3/8"

#99159

Packaged Weight: .25 lb.



**Aquascape offers a complete line of LED pond and landscape lights** to enhance the beauty of any water feature well into the evening hours. Choose from warm-white pond and fountain lighting, path and area lights, or color-changing lights that can be scheduled and controlled from anywhere using our Smart Control Hub paired with the Aquascape Smart Control App on your smartphone or tablet.



# Color-Changing *Lights*

FOR PONDS, WATERFALLS,  
AND FOUNTAINS



Add an impressive range of high-impact color options to your water or fountain feature when you choose Aquascape color-changing LED lights.

SELECT FROM COUNTLESS

*color options*

ADJUST

*brightness levels*

CREATE DIFFERENT

*color themes*

SWITCH AT ANYTIME TO

*true warm white*



[aquascapeinc.com/color-changing-led-lights](http://aquascapeinc.com/color-changing-led-lights)

# CONTROL YOUR LIGHTS

at anytime from anywhere using your smartphone or tablet

Make your water features come to life at night with Aquascape color-changing lights! Simply plug the lights into the Smart Control Hub (sold separately) and pair with the Aquascape Smart Control App to control your lights at anytime from anywhere using your smartphone or tablet.

- Use with Amazon Alexa and Google Home voice commands

NOTE: All color-changing lights require a transformer and Smart Control Hub.



Controlling the color and brightness is quick and easy.



Activate natural, warm white setting at anytime.



Automatically turn lights on/off based on sunset/rise in your area.



Every hub has built-in animations to automatically cycle through desired colors.



## Smart Control Hub

#84074

Packaged Weight: .75 lb.  
Dimensions: 3.75"L x 2"W x .75"H  
Packaged Dimensions: 4.75"L x 2"W x 4.75"H

- Turn lights on and off or select between lighting color design options
- 150-Watt lighting capacity
- Requires standard 12-volt transformer (see page 76)



Color-Changing Light Remote allows wireless control without the use of a smartphone or tablet—#84073

## COLOR-CHANGING LIGHTS

Aquascape LED color-changing lights provide an impressive range of color options including a white diode that provides a true white when desired. Color-changing lights integrate easily with Aquascape color-changing lighting accessories. Color-changing lights require the Smart Control Hub and standard 12-volt transformer.



Smart Control Hub and standard 12-volt transformer required.



**8-Watt Color-Changing Spotlight**  
#84060

**4.5-Watt Color-Changing Spotlight**  
#84059

**2-Watt Color-Changing Waterfall Light**  
#84057



### FEATURES OF THE POND AND LANDSCAPE LED COLOR-CHANGING LIGHTS

1. Durable, fully-sealed, die-cast **metal housing** with protective finish
2. **Optical lenses** maximize light output
3. High-output color-changing and white **diodes**
4. Removable, injection molded **stand**
5. Removable, injection molded **landscape stake**

MODEL	2-WATT WATERFALL LIGHT	4.5-WATT SPOTLIGHT	8-WATT SPOTLIGHT
LUMENS	52 lm / White	128 lm / White	223 lm / White
WATTAGE	2W±10%	4.5W±10%	8W±10%
VOLTAGE MIN-MAX	10.8V – 15V	10.8V – 15V	10.8V – 15V
TEMPERATURE IN KELVIN	3,000 K	3,000 K	3,000 K
COLOR RENDERING INDEX (CRI)	70 / White	70 / White	70 / White
BEAM ANGLE SPREAD	30°	30°	30°
BULB LIFE	40,000 hours	40,000 hours	40,000 hours
12V QUICK CONNECT FITTING	✓	✓	✓
MATERIAL	Die-Cast Metal	Die-Cast Metal	Die-Cast Metal
CORD LENGTH	15'	15'	15'
LIGHT DIMENSIONS	2" diameter x 1.5"H	3" diameter x 3"H	3" diameter x 3"H
PACKAGED WEIGHT	1.25 lb.	1.25 lb.	2.75 lb.
PACKAGED DIMENSIONS	4.75"L x 4.5"W x 7.5"H	5.25"L x 5.25"W x 13.25"H	6.25"L x 6.25"W x 16.25"H

## COLOR-CHANGING FOUNTAIN LIGHTS

The Aquascape LED color-changing fountain lights provide both color-changing and white diodes for an impressive range of color options. They integrate easily with Aquascape color-changing lighting accessories and install easily into the top of decorative fountains.



**Color-Changing Fountain Light**

**#84072**

Requires Smart Control Hub for color-changing lights and standard 12-volt transformer.



**Color-Changing Fountain Light Kit**

**#84055**

Pre-wired kit includes light, remote control and transformer. Ideal for fountain applications only requiring one light.

**NOTE:** Not compatible with Smart Control Hub



### FEATURES OF THE COLOR-CHANGING FOUNTAIN LIGHT

1. Powerful **LED diodes** provide stunning light output
2. Durable, **injection-molded housing** is built to last
3. Integrated, removable **barb fitting** allows for quick and easy attachment to fountain tubing
4. Integrated **quick-connect fitting** is compatible with Aquascape color-changing lighting accessories.

MODEL	COLOR-CHANGING FOUNTAIN LIGHT	COLOR-CHANGING FOUNTAIN LIGHT KIT
LUMENS	20 lm / White	20 lm / White
WATTAGE	2W±10%	2W±10%
VOLTAGE MIN-MAX	10.8V – 15V	10.8V – 15V
TEMPERATURE IN KELVIN	3,000 K	3,000 K
COLOR RENDERING INDEX (CRI)	70 / White	70 / White
BEAM ANGLE SPREAD	30°	30°
BULB LIFE	40,000 hours	40,000 hours
12V QUICK CONNECT FITTING	✓	✓
MATERIAL	Plastic	Plastic
CORD LENGTH	15'	15'
INCLUDES REQUIRED TRANSFORMER	—	✓
REQUIRES SMART CONTROL HUB	✓	—
LIGHT DIMENSIONS	1.5" diameter x 2.5"H	1.5" diameter x 2.5"H
PACKAGED WEIGHT	.5 lb.	2.25 lb.
PACKAGED DIMENSIONS	3.75"L x 1.75"W x 8.25"H	5.5"L x 2.75"W x 7.75"H

## COLOR-CHANGING LIGHT EXTENSION CABLES

The Aquascape color-changing lighting extension cables allow for simple extension of Aquascape color-changing lighting. They are ideal for use with our 12-volt quick-connect transformers and 3-way and 6-way splitters. The 12-volt quick-connect components eliminate the need to cut wires and provide a weatherproof seal. Not compatible with Aquascape LED white lights.



**25' Color-Changing Light Extension Cable**

**#84069**



**25' 5-Outlet Color-Changing Light Extension Cable**

**#84070**

- Provides a quick-connect fitting every 5-feet

## COLOR-CHANGING LIGHT SPLITTERS

Aquascape color-changing splitters provide a simple connection of 3 or 6 color-changing fixtures to a single power source. Multiple 3-way and 6-way splitters can be chained together to attach additional fixtures. Not compatible with Aquascape LED white lights.



**3-Way Color-Changing Light Splitter**

**#84062**



**6-Way Color-Changing Light Splitter**

**#84068**

MODEL	25' COLOR-CHANGING EXTENSION CABLE	5-OUTLET COLOR-CHANGING EXTENSION CABLE	3-WAY COLOR-CHANGING SPLITTER	6-WAY COLOR-CHANGING SPLITTER
QUICK-CONNECT CONNECTIONS	1	5	3	6
TYPE OF QUICK-CONNECT	5-Prong	5-Prong	5-Prong	5-Prong
CORD LENGTH	25'	25'	6"	36"
PACKAGED WEIGHT	1.25 lb.	1.5 lb.	.25 lb.	.75 lb.
PACKAGED DIMENSIONS	7.25"L x 1.75"W x 5.75"H	7"L x 2.5"W x 6.25"H	4"L x 1.5"W x 3"H	7.25"L x 1.75"W x 2"H

### 3-LIGHT SPOTLIGHT KIT

The Pond and Landscape LED 3-Light Spotlight Kit is perfect for highlighting fountains, lighting up container water gardens, or accenting your ecosystem pond. The natural warm white of the three pre-wired 1-Watt LED lights give a warm glow to your water feature. The 12-volt quick-connect components integrate easily with other Aquascape lights, and are simple and easy to install. The Pond and Landscape LED Spotlight Kit includes three pre-wired 1-Watt LED lights, one 6-Watt 12V Quick-Connect Transformer, and one automatic on/off Photocell with Digital Timer.



#### 3-Light Spotlight Kit

#84030

Packaged Weight: 4 lb.

Packaged Dimensions: 16.5"L x 3.5"W x 12"H



#### FEATURES OF THE 3-LIGHT SPOTLIGHT KIT

1. Durable, **injection molded housing** is built to last
2. Included **ground stake** can be used to easily install the light in the landscape
3. Powerful LED with **optical lens** maximizes light output
4. Included **Photocell with Digital Timer** automatically controls the lights

#### WIRING DIAGRAM

1. (3) 1-Watt LED Spotlights (included)
2. Quick-Connect Photocell (included)
3. 6-Watt **Low Voltage** Quick-Connect Transformer (included)

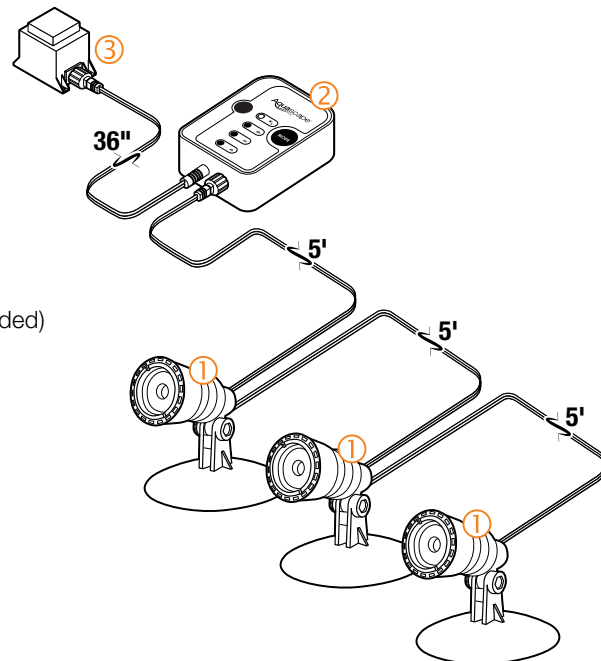

## WARM WHITE LIGHTS

Aquascape pond and landscape LED lights extend the viewing hours of your pond, waterfall, fountain, or container water garden. Excellent for both pond and landscape use, these natural, warm, white lights are easy to install and can be combined with other lights to enhance your outdoor living space.



### 1-Watt Waterfall Light

#84032

### 1-Watt Spotlight

#84031

### 3-Watt Spotlight

#84033

### 6-Watt Spotlight

#84034



### FEATURES OF THE POND AND LANDSCAPE LED LIGHTS

1. Durable, fully-sealed, **die-cast metal housing** with protective finish
2. **Optical lenses** maximize light output
3. High-output white **diodes**
4. Removable, injection molded **stand**
5. Removable, injection molded **landscape stake**

MODEL	1-WATT WATERFALL LIGHT	1-WATT SPOTLIGHT	3-WATT SPOTLIGHT	6-WATT SPOTLIGHT
LUMENS	45 lm	45 lm	150 lm	340 lm
WATTAGE	1.2W±10%	1.2W±10%	3W±10%	5.8W±10%
VOLTAGE MIN-MAX	9V – 15V	9V – 15V	9V – 15V	9V – 15V
TEMPERATURE IN KELVIN	3,000 K	3,000 K	3,000 K	3,000 K
COLOR RENDERING INDEX (CRI)	75	75	75	75
BEAM ANGLE SPREAD	30°	30°	30°	30°
BULB LIFE	40,000 hours	40,000 hours	40,000 hours	40,000 hours
12V QUICK CONNECT FITTING	✓	✓	✓	✓
MATERIAL	Die-Cast Metal	Die-Cast Metal	Die-Cast Metal	Die-Cast Metal
CORD LENGTH	14.5'	14.5'	14.5'	14.5'
LIGHT DIMENSIONS	2" diameter x 1.5"H	1.25" diameter x 2"H	3" diameter x 3"H	3" diameter x 3"H
PACKAGED WEIGHT	1 lb.	1 lb.	2.5 lb.	2.75 lb.
PACKAGED DIMENSIONS	4.75"L x 4.5"W x 7.5"H	4.75"L x 3.75"W x 11"H	5"L x 5"W x 13"H	6.25"L x 6"W x 14"H



Also Available in 6-Packs



### 1-Watt Waterfall Light 6-Pack

#84046

Packaged Weight: 5.75 lb.  
Packaged Dimensions: 14"L x 12"W x 7"H

### 1-Watt Spotlight 6-Pack

#84045

Packaged Weight: 5.25 lb.  
Packaged Dimensions: 13.5"L x 9.75"W x 6"H

### 3-Watt Spotlight 6-Pack

#84047

Packaged Weight: 13.5 lb.  
Packaged Dimensions: 17.5"L x 15.5"W x 13.5"H

### 6-Watt Spotlight 6-Pack

#84048

Packaged Weight: 13.75 lb.  
Packaged Dimensions: 17.5"L x 15.25"W x 7.25"H

## WARM WHITE FOUNTAIN LIGHTS

The Aquascape LED Fountain Lights are an excellent way to enhance your decorative fountain. The integrated fitting makes it quick and easy to install into the top of the tubing, and settles perfectly into the core of the fountain. The natural warm color gives off a warm white light, lighting up the water as it spills over the edge. The fountain lights integrate easily with other 12-volt quick-connect components.



Fountain Light  
#84008



Fountain Light Kit with Transformer  
#84009



### FEATURES OF THE FOUNTAIN LIGHT

1. Powerful **LED diodes** provide stunning, warm light output
2. Durable, **injection-molded housing** is built to last
3. **Integrated, removable barb fitting** allows for quick and easy attachment to fountain tubing
4. Integrated **quick-connect fitting** is compatible with Aquascape quick-connect transformers, splitters, and extension cables.

MODEL	FOUNTAIN LIGHT	FOUNTAIN LIGHT KIT
LUMENS	24 lm	24 lm
WATTAGE	2.5W±10%	2.5W±10%
VOLTAGE MIN-MAX	10.8V – 15V	10.8V – 15V
TEMPERATURE IN KELVIN	3,000 K	3,000 K
COLOR RENDERING INDEX (CRI)	70	70
BEAM ANGLE SPREAD	30°	30°
BULB LIFE	40,000 hours	40,000 hours
12V QUICK CONNECT FITTING	✓	✓
MATERIAL	Plastic	Plastic
CORD LENGTH	15'	15'
LIGHT DIMENSIONS	1.5" diameter x 2.5"H	1.5" diameter x 2.5"H
TRANSFORMER	—	✓
PACKAGED WEIGHT	1 lb.	2 lb.
PACKAGED DIMENSIONS	2.75"L x 2.5"W x 8.25"H	5.5"L x 2.5"W x 7.25"H



## PATH AND AREA LANDSCAPE LIGHTS

Aquascape Path and Area LED Landscape Lights make it easy to illuminate any landscape, including areas surrounding waterfalls, ponds, and fountains. These energy-efficient LED lights provide beauty, safety, and visibility in any residential or commercial space. The two styles available are both constructed out of durable brass and include a heavy-duty stake. These lights integrate easily with other 12-volt quick-connect components.



Hat Top Path and Area Landscape Light

#84063



Dome Top Path and Area Landscape Light

#84064



### FEATURES OF THE PATH AND AREA LANDSCAPE LIGHTS

1. Durable **brass construction** with antique bronze finish
2. 3-foot **lead wire** with quick-connect fitting simplifies installation
3. Energy-efficient 3-Watt **LED bulb**
4. **Acrylic lens** protects LED bulb from outdoor elements
5. Highly reflective **white ceramic paint** for maximum light output
6. **Heavy-duty stake** provides simple and secure installation
7. Water-tight **silicone sealed wire** exit prevents moisture and insects from entering

MODEL	HAT TOP	DOME TOP
LUMENS	270 lm	270 lm
WATTAGE	3W±10%	3W±10%
VOLTAGE MIN-MAX	9V – 15V	9V – 15V
TEMPERATURE IN KELVIN	2,700 K	2,700 K
COLOR RENDERING INDEX (CRI)	80	80
BEAM ANGLE SPREAD	120°	90°
BEAM SPREAD DIAMETER	6.5'	6'
BULB LIFE	40,000 hours	40,000 hours
12V QUICK CONNECT FITTING	✓	✓
MATERIAL	Brass	Brass
CORD LENGTH	3'	3'
LIGHT DIMENSIONS	6.5" diameter x 18.25"H	6.5" diameter x 18.25"H
PACKAGED WEIGHT	1.75 lb.	1.75 lb.
PACKAGED DIMENSIONS	5.75"L x 5.75"W x 9.25"H	5.75"L x 5.75"W x 9.25"H



Hat Top Path and Area Landscape Light  
6-Pack

#84065

Packaged Weight: 9 lb.  
Packaged Dimensions: 14"L x 8"W x 10"H



Also Available in 6-Packs

Dome Top Path and Area Landscape Light  
6-Pack

#84066

Packaged Weight: 9.5 lb.  
Packaged Dimensions: 14"L x 8"W x 10"H

## LOW VOLTAGE ACCESSORIES

Aquascape low-voltage accessories are designed for use with low voltage lighting and other low voltage components, including Pond Powerheads.



### Quick-Connect Photocell with Timer

**#84039**

Packaged Weight: .75 lb.

Dimensions: 2"L x 1.25"W x 3.25"H with a 36" cord

- Can be used to control Aquascape white and color-changing lights
- Auto on at dusk/off at dawn or 4, 6, 8 hour timer option
- Built-in memory setting in case of power loss
- Integrates easily with other 12-volt quick-connect components
- Up to 60-Watt capacity



### 25' Quick-Connect Extension Cable

**#98998**

Packaged Weight: 1 lb.

- 25' cord length



### 25' 5-Outlet Quick-Connect Extension Cable

**#84023**

Packaged Weight: 1 lb.

- 25' cord length
- Provides a quick-connect fitting every 5-feet



### 3-Way Quick-Connect Splitter

**#98489**

Packaged Weight: .5 lb.

- 6" cord length



### 6-Way Quick-Connect Splitter

**#84022**

Packaged Weight: .75 lb.

- 36" cord length



POWER

**Aquascape offers a variety of power accessories** including an array of low-voltage transformers and a Smart Control Plug designed to control your Aquascape products with the Smart Control App on your smartphone or tablet.

## TRANSFORMERS

Aquascape transformers provide an economical solution for operating low-voltage products such as lighting or Pond Powerheads. A variety of power options are available and each transformer includes quick-connect connections for quick and easy installation.



**6-Watt Low Voltage Quick-Connect Transformer**  
#98375

**20-Watt Low Voltage Quick-Connect Transformer**  
#98485

**60-Watt Low Voltage Quick-Connect Transformer**  
#98486



**60-Watt Low Voltage Transformer with Photocell**  
#99070



**150-Watt Low Voltage Transformer with Photocell**  
#01002

MODEL	6-WATT	20-WATT	60-WATT	60-WATT WITH PHOTOCELL	150-WATT WITH PHOTOCELL
QUICK-CONNECT CONNECTIONS	1	1	1	1	3
PHOTOCELL INCLUDED	—	—	—	✓	✓
TRANSFORMER DIMS	3"L x 1.5"W x 2.25"H	4"L x 1.75"W x 2.5"H	3"L x 6"W x 3"H	3.5"L x 7"W x 2.5"H	4"L x 7"W x 3.5"H
PACKAGED WEIGHT	1 lb.	1.75 lb.	3.5 lb.	4 lb.	8 lb.
PACKAGED DIMS	6.5"L x 3"W x 4.5"H	6.25"L x 2"W x 4"H	6"L x 2"W x 4"H	8.75"L x 7.5"W x 4.25"H	7.75"L x 4"W x 4"H

## SMART CONTROL PLUG

The Aquascape Smart Control Plug is the easiest way to add smart controls to your existing Aquascape water features, allowing you to control your lights, or any other outdoor appliance from anywhere using your smartphone or tablet.

- Numbered outlets allow simple, clear set-up
- Power monitoring shows energy consumption of connected devices
- Adequate wireless coverage required (2.4GHz supported)



### Smart Control Plug

#82001

Packaged Weight: .5 lb.

Dimensions: 6"L x 1.5"W x 5.5"H with a 6" cord

Packaged Dimensions: 7"L x 2"W x 6"H



Control Aquascape water features with your smartphone or tablet



### FEATURES OF THE SMART CONTROL PLUG

1. **Weatherproof button caps** on outlets protect the unit when not in use
2. **Integrated hang tag** provides secure mounting option
3. **WiFi pairing button/indicator** allows for quick and easy connection to your smartphone or tablet
4. **Numbered outlets** allow simple, clear setup
5. **Power monitoring** shows energy consumption of connected devices

Monitor your energy usage on the Aquascape Smart Control App to make informed decisions about your energy consumption.





**Aquascape Water Treatments** make it simple and affordable to enjoy a clean, clear, and healthy ecosystem pond, Pondless® Waterfall, or decorative fountain with the complete line of Aquascape water treatment products.

Aquascape has a variety of options to naturally and efficiently balance your pond, waterfall, or fountain. Select from Simple Solutions, Beneficial Bacteria, Problem Solving, Algae Fighting, Water Conditioners, Sludge Fighting, Fountain Treatments, and Lake and Large Pond Treatments.

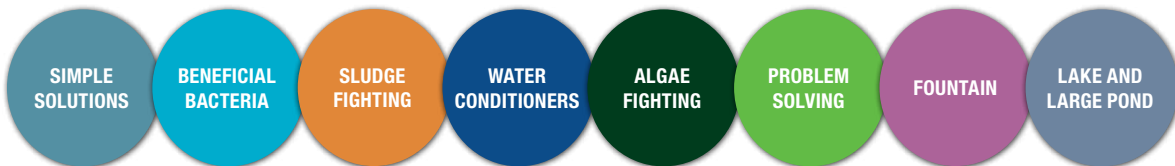

## SIMPLE SOLUTIONS WATER TREATMENTS

Aquascape Simple Solutions water treatments are the easy way to keep water features clean, clear, and healthy. Maintain your water feature by tackling most water quality and clarity issues with our line of easy-to-use water treatments and products.



## APPLICATION OPTIONS

Choose between simple pump top options or one of our **Automatic Dosing Systems** which automatically add treatment, so you don't have to! For more information, see page 80, 82, and 83.

Treat Manually

OR

Treat Automatically



### Manual Pump Top Bottles

Use the convenient pump top bottles to manually add treatments on a weekly or bi-weekly basis.



NEW

### Smart Pond Dosing System XT

Great for use in a variety of features, including larger ponds.  
See page 80.



### Automatic Dosing System

Great for use in features 5,000 gallons or less.  
See page 82.

### APPLICATION



### APPLICATION

Dose directly into ponds, skimmers, waterfall vaults, or fountains.

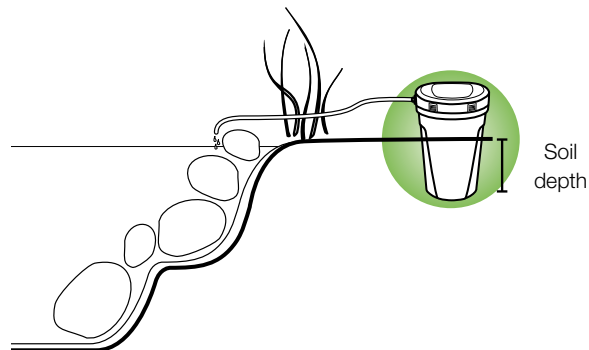

## SMART POND DOSING SYSTEM XT



The Smart Pond Dosing System XT is an electronically-operated dispenser that accurately and consistently applies specially-formulated water treatments to water features, including large scale bodies of water. Pair the control panel to the Aquascape Smart Control App to control, monitor, and receive alerts on your smartphone or tablet.



### Smart Pond Dosing System XT

#40040

Packaged Weight: 6 lb.

Packaged Dimensions: 11.5"L x 9.75"W x 15.25"H

- For use with ponds, waterfalls, and fountains
- Manage treating larger water features with ease

**Includes:** enclosure, (1) control panel, (1) treatment intake with low treatment alert, internal and external treatment tubing, and low-voltage transformer

Compatible with XT Simple Solution Water Treatments (sold separately) see pages 83-87

Add multiple treatments simultaneously with a Controller Add-on Kit



### Smart Pond Dosing System Controller Add-On Kit

#40042

Packaged Weight: .75 lb.

Packaged Dimensions: 11"L x 4.75"W x 3.75"H

- Add to Smart Pond Dosing System XT to dose two 64 oz. treatments simultaneously
- Includes intake assembly, tubing, and power cable

### Smart Pond Dosing System Pump Cartridge

#40041



Packaged Weight: .04 lb.

Dimensions: 2"L x 2.5"W x 2"H

- Peristaltic pump for use with the Smart Pond Dosing System XT
- Replace once per season to maintain dosing accuracy



NEW

## SMART POND DOSING SYSTEM XT

### FEATURES OF THE SMART POND DOSING SYSTEM XT

1. **Durable housing** is built to last and can be buried to conceal
2. **Hood design with mounted control panels** hides and protects components from weather conditions
3. **Large internal space** fits one large gallon or 1-2 64 oz. treatment bottles. Water treatments sold separately, (see pages 83-87).
4. Easily apply two different treatments simultaneously with an optional **Controller Add-On Kit** (sold separately)
5. Push-button **control panel** is easily calibrated to your water feature size



### Low-treatment Alert

Low-treatment alerts you when the treatment is 90% empty

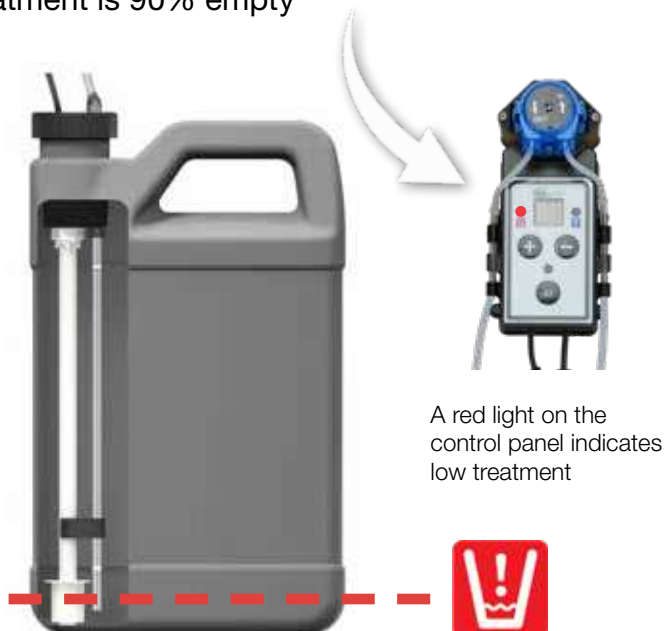

A red light on the control panel indicates low treatment

### Smart Control

Connect to the app to control, monitor, and receive alerts on your smartphone or tablet



## AUTOMATIC DOSING SYSTEM (G1)

The original Automatic Dosing System effectively applies Simple Solutions water treatments to keep ponds, fountains, and waterfalls containing up to 5,000 gallons.



**Automatic Dosing System for Ponds**

#96030

Packaged Weight: 6 lb.

Packaged Dimensions: 9"L x 8.25"W x 14.5"H

- Free water treatment included (Maintain for Ponds)
- Ideal for use with ponds



**Automatic Dosing System for Fountains**

#96031

Packaged Weight: 6 lb.

Packaged Dimensions: 9"L x 8.25"W x 14.5"H

- Free water treatment (Prevent for Fountains)
- Ideal for use with fountains and Pondless® Waterfalls



### FEATURES OF THE AUTOMATIC DOSING SYSTEM

1. Use the **plus (+) and minus (-) buttons** to select the approximate number of gallons in your water feature.
2. When pressed the **X2 button** will double the dosage for new ponds, problem ponds, or after a cleaning. When held, the system will enter a priming mode, automatically priming the system for newly installed water treatment pouches.



**Automatic Dosing System Replacement Pump Cartridge**

#96040

Packaged Weight: .1 lb.

Packaged Dimensions: 3.5"L x 1"W x 1.7"H

- Peristaltic pump for use with Automatic Dosing System (G1)
- Replace once per season to maintain dosing accuracy

## SIMPLE SOLUTIONS TREATMENTS FOR PONDS

### MAINTAIN FOR PONDS

Staple water treatment for ponds, designed to keep ponds clean and healthy

#### WHAT IT DOES

- Reduces maintenance
- Supports a healthy ecosystem
- Provides healthy and crystal-clear water conditions

#### HOW IT WORKS

- Combines our most effective water treatments into one powerful formulation (like a multivitamin)
- Uses a beneficial bacteria blend, phosphate binder, flocculant clarifier, and a detoxifier

### XT

NEW

Designed only for use with the Smart Pond XT System and available in both 64 oz. and 1 gallon options. Triple-concentrated formulation also available for use in larger ponds or extending the duration between treatment replacements. [See page 80 for system information.](#)

PRODUCT NUMBER	40048	40049	40032	40033
CONCENTRATION	Standard 1X	Standard 1X	<b>3X</b>	<b>3X</b>
PACKAGE SIZE	64 oz. / 1.89 L	1 gal. / 3.78 L	64 oz. / 1.89 L	1 gal. / 3.78 L
PACKAGED WEIGHT	4.4 lb.	8.7 lb.	4.4 lb.	8.7 lb.



### ADS (G1)

Designed only for use with the original Automatic Dosing System, available in 32 oz. pouch. [See page 82 for system information.](#)

PRODUCT NUMBER	96032
PACKAGE SIZE	32 oz. / 946 ml pouch
PACKAGED WEIGHT	2.25 lb.



### PUMP TOP

Apply the treatment manually throughout the season using the pump top option. To apply treatments automatically consider one of the automatic dosing options.

PRODUCT NUMBER	96057	96058	96059	96060
PACKAGE SIZE	8 oz. / 236 ml	16 oz. / 473 ml	32 oz. / 946 ml	1 gal. / 3.78 L
PACKAGED WEIGHT	.75 lb.	1.25 lb.	2.5 lb.	8 lb.
1 PUMP TREATS	100 gal. / 378 L	100 gal. / 378 L	100 gal. / 378 L	600 gal. / 2,268 L
1 BOTTLE TREATS	5,000 gal. / 18,900 L	10,000 gal. / 37,800 L	20,000 gal. / 75,600 L	80,000 gal. / 302,400 L



SIMPLE SOLUTIONS TREATMENTS FOR PONDS

CLEAR FOR PONDS

Use to clear unsightly water conditions, including cloudy and discolored water

WHAT IT DOES

- Clarifies water and resolves water quality problems
- Mitigates cloudy or discolored water and issues with debris attached to rocks and gravel

HOW IT WORKS

- Uses a concentrated formula of clarifiers and a phosphate binder which work to prevent issues with water clarity and debris buildup

XT

Designed only for use with the Smart Pond XT System and available in both 64 oz. and 1 gallon options. Triple-concentrated formulation also available for use in larger ponds or extending the duration between treatment replacements. See page 80 for system information.



PRODUCT NUMBER	40050	40051	40034	40035
CONCENTRATION	Standard 1X	Standard 1X	3X	3X
PACKAGE SIZE	64 oz. / 1.89 L	1 gal. / 3.78 L	64 oz. / 1.89 L	1 gal. / 3.78 L
PACKAGED WEIGHT	4.4 lb.	8.7 lb.	4.4 lb.	8.7 lb.



ADS (G1)

Designed only for use with the original Automatic Dosing System, available in 32 oz. pouch. See page 82 for system information.

PRODUCT NUMBER	96033
PACKAGE SIZE	32 oz. / 946 ml pouch
PACKAGED WEIGHT	2.25 lb.



PUMP TOP

Apply the treatment manually throughout the season using the pump top option. To apply treatments automatically consider one of the automatic dosing options.

PRODUCT NUMBER	96065	96066	96067	96068
PACKAGE SIZE	8 oz. / 236 ml	16 oz. / 473 ml	32 oz. / 946 ml	1 gal. / 3.78 L
PACKAGED WEIGHT	.75 lb.	1.25 lb.	2.5 lb.	8 lb.
1 PUMP TREATS	100 gal. / 378 L	100 gal. / 378 L	100 gal. / 378 L	600 gal. / 2,268 L
1 BOTTLE TREATS	5,000 gal. / 18,900 L	10,000 gal. / 37,800 L	20,000 gal. / 75,600 L	80,000 gal. / 302,400 L



SIMPLE SOLUTIONS TREATMENTS FOR PONDS

CLEAN FOR PONDS

Use to naturally reduce organic sludge and debris

WHAT IT DOES

- Reduces organic waste caused by uneaten fish food, fish waste, and leaves or debris
- Naturally cleans rocks, gravel and filters
- Keeps ponds looking clean and clear

HOW IT WORKS

- Uses a powerful blend of heterotrophic bacteria to digest organic waste and sludge

XT

NEW

Designed only for use with the Smart Pond XT System and available in both 64 oz. and 1 gallon options. Triple-concentrated formulation also available for use in larger ponds or extending the duration between treatment replacements. See page 80 for system information.

PRODUCT NUMBER	40052	40053	40036	40037
CONCENTRATION	Standard 1X	Standard 1X	3X	3X
PACKAGE SIZE	64 oz. / 1.89 L	1 gal. / 3.78 L	64 oz. / 1.89 L	1 gal. / 3.78 L
PACKAGED WEIGHT	4.4 lb.	8.7 lb.	4.4 lb.	8.7 lb.



ADS (G1)

Designed only for use with the original Automatic Dosing System, available in 32 oz. pouch. See page 82 for system information.

PRODUCT NUMBER	96034
PACKAGE SIZE	32 oz. / 946 ml pouch
PACKAGED WEIGHT	2.25 lb.



PUMP TOP

Apply the treatment manually throughout the season using the pump top option. To apply treatments automatically consider one of the automatic dosing options.

PRODUCT NUMBER	96061	96062	96063	96064
PACKAGE SIZE	8 oz. / 236 ml	16 oz. / 473 ml	32 oz. / 946 ml	1 gal. / 3.78 L
PACKAGED WEIGHT	.75 lb.	1.25 lb.	2.5 lb.	8 lb.
1 PUMP TREATS	100 gal. / 378 L	100 gal. / 378 L	100 gal. / 378 L	600 gal. / 2,268 L
1 BOTTLE TREATS	5,000 gal. / 18,900 L	10,000 gal. / 37,800 L	20,000 gal. / 75,600 L	80,000 gal. / 302,400 L



SIMPLE SOLUTIONS TREATMENTS FOR PONDS

PROTECT FOR PONDS

Use to protect pond fish such as koi and goldfish. Great for use after handling or cleanouts.

**WHAT IT DOES**

- Reduces fish stress
- Prevents parasites and infections
- Accelerates healing of superficial wounds, scrapes, and breeding abrasions

**HOW IT WORKS**

- Uses an all-natural formulation of tea tree oil and other plant-based biopolymers

XT

Designed only for use with the Smart Pond XT System and available in both 64 oz. and 1 gallon options. Triple-concentrated formulation also available for use in larger ponds or extending the duration between treatment replacements. **See page 80 for system information.**



PRODUCT NUMBER	40054	40055	40038	40039
CONCENTRATION	Standard 1X	Standard 1X	3X	3X
PACKAGE SIZE	64 oz. / 1.89 L	1 gal. / 3.78 L	64 oz. / 1.89 L	1 gal. / 3.78 L
PACKAGED WEIGHT	4.4 lb.	8.7 lb.	4.4 lb.	8.7 lb.



ADS (G1)

Designed only for use with the original Automatic Dosing System, available in 32 oz. pouch. **See page 82 for system information.**

PRODUCT NUMBER	96035
PACKAGE SIZE	32 oz. / 946 ml pouch
PACKAGED WEIGHT	2.25 lb.



PUMP TOP

Apply the treatment manually throughout the season using the pump top option. To apply treatments automatically consider one of the automatic dosing options.

PRODUCT NUMBER	96069	96070	96071	96072
PACKAGE SIZE	8 oz. / 236 ml	16 oz. / 473 ml	32 oz. / 946 ml	1 gal. / 3.78 L
PACKAGED WEIGHT	.75 lb.	1.25 lb.	2.5 lb.	8 lb.
1 PUMP TREATS	100 gal. / 378 L	100 gal. / 378 L	100 gal. / 378 L	600 gal. / 2,268 L
1 BOTTLE TREATS	5,000 gal. / 18,900 L	10,000 gal. / 37,800 L	20,000 gal. / 75,600 L	80,000 gal. / 302,400 L



## SIMPLE SOLUTIONS TREATMENTS FOR FOUNTAINS AND WATERFALLS

PREVENT FOR FOUNTAINS	CLEAN FOR FOUNTAINS
<p>Staple product for fountains, cleans and clarifies</p> <p><b>WHAT IT DOES</b></p> <ul style="list-style-type: none"> <li>Controls white-scale buildup, foam, and stains</li> <li>Helps to clear unsightly water conditions and debris that attaches to surfaces</li> </ul> <p><b>HOW IT WORKS</b></p> <ul style="list-style-type: none"> <li>Contains a special blend of clarifiers and scale remover that will not damage fountain surface</li> </ul> <p>NOTE: Not for use with water features containing fish</p>	<p>Used to clear unsightly suspended debris</p> <p><b>WHAT IT DOES</b></p> <ul style="list-style-type: none"> <li>Keeps waterfalls and fountains clean, clear, and healthy</li> <li>Reduces maintenance and improves water quality</li> </ul> <p><b>HOW IT WORKS</b></p> <ul style="list-style-type: none"> <li>Uses a flocculant clarifier and phosphate binder to help clear and prevent debris</li> </ul>

### XT

Designed only for use with the Smart Pond XT System and available in both 64 oz. and 1 gallon options. Triple-concentrated formulation also available for use in larger ponds or extending the duration between treatment replacements. [See page 80 for system information.](#)



PRODUCT NUMBER	40056	40057	40058	40059
PACKAGE SIZE	64 oz. / 1.89 L	1 gal. / 3.78 L	64 oz. / 1.89 L	1 gal. / 3.78 L
PACKAGED WEIGHT	4.4 lb.	8.7 lb.	4.4 lb.	8.7 lb.



### ADS (G1)

Designed only for use with the original Automatic Dosing System, available in 32 oz. pouch. [See page 82 for system information.](#)

PRODUCT NUMBER	96042	96037
PACKAGE SIZE	32 oz. / 946 ml pouch	32 oz. / 946 ml pouch
PACKAGED WEIGHT	2.25 lb.	2.25 lb.



### PUMP TOP

Apply the treatment manually throughout the season using the pump top option. To apply treatments automatically consider one of the automatic dosing options.

PRODUCT NUMBER	96073	96077	96074	96078	96075	96079	96076	96080
PACKAGE SIZE	8 oz. / 236 ml	16 oz. / 473 ml	16 oz. / 473 ml	32 oz. / 946 ml	32 oz. / 946 ml	32 oz. / 946 ml	1 gal. / 3.78 L	1 gal. / 3.78 L
PACKAGED WEIGHT	.75 lb.	1.25 lb.	1.25 lb.	2.5 lb.	2.5 lb.	2.5 lb.	8 lb.	8 lb.
1 PUMP TREATS	100 gal. / 378 L	100 gal. / 378 L	100 gal. / 378 L	100 gal. / 378 L	100 gal. / 378 L	100 gal. / 378 L	600 gal. / 2,268 L	600 gal. / 2,268 L
1 BOTTLE TREATS	5,000 gal. / 18,900 L	10,000 gal. / 37,800 L	10,000 gal. / 37,800 L	20,000 gal. / 75,600 L	20,000 gal. / 75,600 L	20,000 gal. / 75,600 L	80,000 gal. / 302,400 L	80,000 gal. / 302,400 L



## BENEFICIAL BACTERIA

### Beneficial Bacteria

#98886, #98887, #98888, #40002, #98885

- Contains 8 strains of bacteria including photosynthetic
- Contains marigold and vitamin B



PRODUCT NUMBER	98886	98887	98888	40002	98885
PACKAGE SIZE	8 oz. / 236 ml	16 oz. / 473 ml	32 oz. / 946 ml	32 oz. / 946 ml pouch	1 gal. / 3.78 L
PACKAGED WEIGHT	.75 lb.	1.25 lb.	2.5 lb.	2.25 lb.	8 lb.
1 PUMP TREATS	100 gal. / 378 L	100 gal. / 378 L	100 gal. / 378 L	—	600 gal. / 2,268 L
1 BOTTLE TREATS	5,000 gal. / 18,900 L	10,000 gal. / 37,800 L	20,000 gal. / 75,600 L	20,000 gal. / 75,600 L	80,000 gal. / 302,400 L

### Beneficial Bacteria Concentrate

#98925, #98948, #98949, #98950

- Contains 8 strains of bacteria including photosynthetic
- Contains marigold and vitamin B
- Ideal for larger ponds



PRODUCT NUMBER	98925	98948	98949	98950
PACKAGE SIZE	4.4 oz. / 125 g	8.8 oz. / 250 g	1.1 lb. / 500 g	7 lb. / 3.2 kg
PACKAGED WEIGHT	.25 lb.	.75 lb.	1.25 lb.	7.5 lb.
1 SCOOP TREATS	1,300 gal. / 4,914 L	1,300 gal. / 4,914 L	1,300 gal. / 4,914 L	1,300 gal. / 4,914 L
1 CONTAINER TREATS	26,000 gal. / 98,280 L	52,000 gal. / 196,560 L	104,000 gal. / 393,120 L	665,600 gal. / 2,515,968 L

### Cold Water Beneficial Bacteria

#98892, #98893, #98894, #96021

- Reduces ammonia, nitrite, and organic debris
- Ideal for use in water colder than 50°F (5°C)



PRODUCT NUMBER	98892	98893	98894	96021
PACKAGE SIZE	8 oz. / 236 ml	16 oz. / 473 ml	32 oz. / 946 ml	1 gal. / 3.78 L
PACKAGED WEIGHT	.75 lb.	1.25 lb.	2.5 lb.	8 lb.
1 PUMP TREATS	100 gal. / 378 L	100 gal. / 378 L	100 gal. / 378 L	600 gal. / 2,268 L
1 BOTTLE TREATS	5,000 gal. / 18,900 L	10,000 gal. / 37,800 L	20,000 gal. / 75,600 L	80,000 gal. / 302,400 L



## BENEFICIAL BACTERIA

### Pond Starter Bacteria

**#96013, #96014, #96015, #96008**

- Quickly establishes biological ecosystem
- Great for spring start-ups and new ponds
- Safe for fish, plants, and animals



PRODUCT NUMBER	96013	96014	96015	96008
PACKAGE SIZE	8 oz. / 236 ml	16 oz. / 473 ml	32 oz. / 946 ml	1 gal. / 3.78 L
PACKAGED WEIGHT	.75 lb.	1.25 lb.	2.5 lb.	8 lb.
1 PUMP TREATS	100 gal. / 378 L	100 gal. / 378 L	100 gal. / 378 L	600 gal. / 2,268 L
1 BOTTLE TREATS	5,000 gal. / 18,900 L	10,000 gal. / 37,800 L	20,000 gal. / 75,600 L	80,000 gal. / 302,400 L

### Bacteria Bubble Tabs

**#98951, #98930**

- Keeps pond water clean and clear
- Maintains a balanced ecosystem
- Reduces pond maintenance



PRODUCT NUMBER	98951	98930
PACKAGE SIZE	36 Tabs	72 Tabs
PACKAGED WEIGHT	.25 lb.	.75 lb.
1 TABLET TREATS	100 gal. / 378 L	100 gal. / 378 L
1 CONTAINER TREATS	3,600 gal. / 13,608 L	7,200 gal. / 27,216 L

## SLUDGE FIGHTING

### Pond Sludge Remover Packs

**#96081, #96084, #96082**

- Eliminates and prevents pond sludge
- Water soluble packs make it easy to spot treat and treat hard-to-reach areas
- Keeps rocks, gravel, and filters clean



PRODUCT NUMBER	96081	96084	96082
PACKAGE SIZE	18 Packs	36 Packs	72 Packs
PACKAGED WEIGHT	.5 lb.	1 lb.	2.5 lb.
1 PACK TREATS	1,000 gal. / 3,780 L	1,000 gal. / 3,780 L	1,000 gal. / 3,780 L
1 CONTAINER TREATS	18,000 gal. / 68,040 L	36,000 gal. / 120,960 L	72,000 gal. / 272,550 L

### Sludge & Filter Cleaner

**#98889, #98890, #98891, #98883**

- Biological pond and filter cleaner
- Contains 5 strains of heterotrophic bacteria
- Contains marigold and humic acid
- Safe for fish, plants, and animals



PRODUCT NUMBER	98889	98890	98891	98883
PACKAGE SIZE	8 oz. / 236 ml	16 oz. / 473 ml	32 oz. / 946 ml	1 gal. / 3.78 L
PACKAGED WEIGHT	.75 lb.	1.25 lb.	2.5 lb.	8 lb.
1 PUMP TREATS	100 gal. / 378 L	100 gal. / 378 L	100 gal. / 378 L	600 gal. / 2,268 L
1 BOTTLE TREATS	5,000 gal. / 18,900 L	10,000 gal. / 37,800 L	20,000 gal. / 75,600 L	80,000 gal. / 302,400 L

## WATER CONDITIONERS

### Pond Detoxifier

**#98876, #98877, #40005, #96010**

- Makes tap water safe for fish and plants
- Removes and detoxifies chlorine
- Neutralizes ammonia
- Detoxifies and chelates copper and heavy metal



PRODUCT NUMBER	98876	98877	40005	96010
PACKAGE SIZE	8 oz. / 236 ml	16 oz. / 473 ml	32 oz. / 946 ml pouch	1 gal. / 3.78 L
PACKAGED WEIGHT	.75 lb.	1.25 lb.	2.25 lb.	8 lb.
1 PUMP TREATS	100 gal. / 378 L	100 gal. / 378 L	—	600 gal. / 2,268 L
1 BOTTLE TREATS	5,000 gal. / 18,900 L	10,000 gal. / 37,800 L	20,000 gal. / 75,600 L	80,000 gal. / 302,400 L

### Ammonia Neutralizer

**#96050, #96051, #96052**

- Neutralizes large concentrations of toxic ammonia
- Makes pond water safe for fish and plants
- Detoxifies chloramine in tap water



PRODUCT NUMBER	96050	96051	96052
PACKAGE SIZE	16 oz. / 473 ml	32 oz. / 946 ml	1 gal. / 3.78 L
PACKAGED WEIGHT	1.25 lb.	2.5 lb.	8 lb.
1 PUMP TREATS	100 gal. / 378 L	100 gal. / 378 L	600 gal. / 2,268 L
1 BOTTLE TREATS	10,000 gal. / 37,800 L	20,000 gal. / 75,600 L	80,000 gal. / 302,400 L



### Alkalinity Booster

**#96027, #96028**

- Keeps pond water clean and clear
- Maintains a balanced ecosystem
- Reduces pond maintenance



### Activated Pond Carbon

**#80000**

- Removes discoloration and odors
- Made with bamboo carbon
- Clarifies pond water



### Pond Foam Free

**#98909**

- Safely eliminates foam near waterfalls
- Helps keep water clean and clear of foam
- Safe for fish, animals, and plants

PRODUCT NUMBER	96027	96028	80000	98909
PACKAGE SIZE	1.1 lb. / 500 g	9 lb. / 4.08 kg	2.25 lb. / 1 kg	8 oz. / 236 ml
PACKAGED WEIGHT	3 lb.	9.75 lb.	2.25 lb.	.75 lb.
1 SCOOP / PUMP TREATS	125 gal. / 472 L	125 gal. / 472 L	25 gal. / 95 L	100 gal. / 378 L
1 CONTAINER / BOTTLE TREATS	5,000 gal. / 18,900 L	40,750 gal. / 154,035 L	800 gal. / 3,024 L	5,000 gal. / 18,900 L

## ALGAE FIGHTING

### Algaecide

**#96022, #96023, #96024, #96026, #96053**

- No more algae growth
- Controls string algae
- Clears green water
- Can be used on ponds with fish and plants



PRODUCT NUMBER	96022	96023	96024	96026	96053
PACKAGE SIZE	8 oz. / 236 ml	16 oz. / 473 ml	32 oz. / 946 ml	1 gal. / 3.78 L	2.5 gal. / 3.78 L
PACKAGED WEIGHT	.75 lb.	1.25 lb.	2.5 lb.	2.25 lb.	8 lb.
1 TSP. TREATS	50 gal. / 189 L	50 gal. / 189 L	50 gal. / 189 L	50 gal. / 189 L	50 gal. / 189 L
1 BOTTLE TREATS	2,500 gal. / 9,450 L	5,000 gal. / 18,900 L	10,000 gal. / 37,800 L	40,000 gal. / 151,400 L	100,000 gal. / 378,541 L

### EcoBlast™ Contact Granular Algaecide

**#29311, #29312, #29313**

- Eliminates algae from water features on contact
- Can be used at any water temperature
- For use in water features containing live fish and plants



PRODUCT NUMBER	29311	29312	29313
PACKAGE SIZE	8.8 oz. / 250 g	38.4 oz. / 1.1 kg	7 lb. / 3.2 kg
PACKAGED WEIGHT	1 lb.	3 lb.	7 lb.
1 CONTAINER TREATS	200 sq. ft.	780 sq. ft.	2,275 sq. ft.

## Say goodbye to string algae!



For more information, see page 40.

## PROBLEM SOLVING

### SAB Stream & Pond Cleaner

**#98898, #98899, #98900, #98896**

- Breaks down debris
- Maintains a balanced ecosystem
- Reduces pond maintenance
- Phosphate binder



PRODUCT NUMBER	98898	98899	98900	98896
PACKAGE SIZE	4.4 oz. / 125 g	8.8 oz. / 250 g	1.1 lb. / 500 g	7 lb. / 3.2 kg
PACKAGED WEIGHT	.25 lb.	.75 lb.	1.25 lb.	7.5 lb.
1 SCOOP TREATS	120 gal. / 454 L	120 gal. / 454 L	120 gal. / 454 L	1,420 gal. / 5,368 L
1 CONTAINER TREATS	1,200 gal. / 4,536 L	2,400 gal. / 9,072 L	4,900 gal. / 18,597 L	31,240 gal. / 118,256 L

### Barley Straw Extract

**#98903, #98904, #98905, #96012**

- Promotes clean, clear water conditions in ponds and streams
- Starts working instantly
- Concentrated formulation with added enzymes



PRODUCT NUMBER	98903	98904	98905	96012
PACKAGE SIZE	8 oz. / 326 ml	16 oz. / 473 ml	32 oz. / 946 ml	1 gal. / 3.78 L
PACKAGED WEIGHT	.75 lb.	1.25 lb.	2.5 lb.	8 lb.
1 PUMP TREATS	100 gal. / 378 L	100 gal. / 378 L	100 gal. / 378 L	600 gal. / 2,268 L
1 BOTTLE TREATS	5,000 gal. / 18,900 L	10,000 gal. / 37,800 L	20,000 gal. / 75,600 L	80,000 gal. / 302,400 L

### Rapid Clear Flocculant

**#98879, #96049, #40006, #96007**

- Quickly clears cloudy water by clumping debris
- Works within 24 hours
- For best results, use in combination with a Rapid Clear Fine Filter Pad (#80001)



### Rapid Clear Fine Filter Pads

**#80001**

- Speeds-up filtering of flocculated particles
- Works within 24 hours
- For best results, use in combination with Rapid Clear Flocculant water treatments
- Enhances water quality
- Includes three pads



PRODUCT NUMBER	98879	96049	40006	96007	80001
PACKAGE SIZE	8 oz. / 236 ml	16 oz. / 473 ml	32 oz. / 946 ml pouch	1 gal. / 3.78 L	12"W x 24"L
PACKAGED WEIGHT	.75 lb.	1.25 lb.	2.25 lb.	8 lb.	.75 lb.
1 PUMP TREATS	100 gal. / 378 L	100 gal. / 378 L	—	600 gal. / 2,268 L	—
1 BOTTLE TREATS	5,000 gal. / 18,900 L	10,000 gal. / 37,800 L	20,000 gal. / 75,600 L	80,000 gal. / 302,400 L	—

PROBLEM SOLVING



QuickFix Pond Gummy

#96083

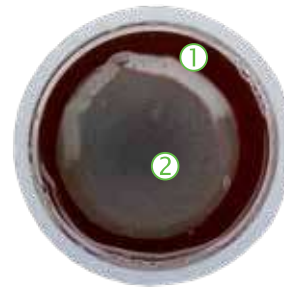

FEATURES OF THE QUICKFIX POND GUMMY

- Each gummy sits in a solution containing a special blend of treatments.
  - Helps clear unsightly water conditions
  - Provides an instantaneous bio-available food source to maximize metabolic activity
- The gummy contains:
  - 320 billion viable bacteria cultures specifically selected for their ability to quickly resolve a variety of pond problems
  - Free enzymes which trigger digestion to help break down organics

Packaged Weight: .25 lb.  
1 package treats 3,000 gal. / 11,340 L

- Rapidly resolves pond problems, including cloudy water
- Innovative gummy makes for quick and easy application
- Targets ammonia, nitrite, and phosphate
- Helps control organic waste and debris

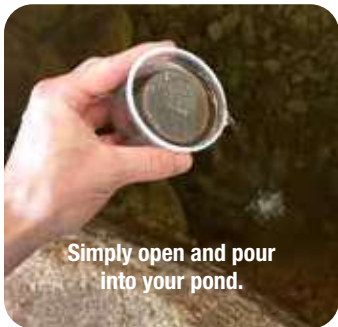

Concentrated Barley Straw Pellets

#96029

- Fast-acting, natural way to clarify pond water
- Comes in a resealable mesh bag
- Contains a blend of bacteria and enzymes



Black Pond Dye

#98884

- Filters sunlight and cools water
- Contains humic acid and enzymes to help balance the pond ecosystem
- Creates a shimmering effect
- One dosage lasts up to 6 weeks



Blue Pond Dye

#98882

- Added enzymes help balance the pond ecosystem
- One dosage lasts up to 6 weeks

PRODUCT NUMBER	96029	98884	98882
PACKAGE SIZE	5 lb. / 2.3 kg	8 oz. / 236 ml	8 oz. / 236 ml
PACKAGED WEIGHT	5.5 lb.	.75 lb.	.75 lb.
1 PUMP TREATS	—	100 gal. / 378 L	600 gal. / 2,268 L
1 CONTAINER / BOTTLE TREATS	1,000 gal. / 3,780 L	5,000 gal. / 18,960 L	5,000 gal. / 18,960 L

## FOUNTAIN TREATMENTS



### Patio Pond Maintenance Tabs

#40004

- Targeted treatment for container water gardens
- Contains 8 pure strains of beneficial bacteria
- Helps optimize water quality
- Safe for fish, animals, and plants



### Fountain Foam Free

#98908

- Safely eliminates foam from water features
- Helps maintain the beauty of your water feature
- Helps keep water clean and clear of foam
- Safe for fish, animals, and plants



### Rock & Fountain Cleaner

#96055

- Quickly eliminates debris from waterfalls, fountains, or streams
- Easy-to-use spray bottle application
- Safe for fish, animals, and plants



### Fountain Maintenance

#40007 #96056

- Safely eliminates scale and debris build-up from water features
- Maintains the beauty of your water feature
- Helps maintain perfect water quality
- Prevents white scale build-up without damaging feature
- Safe for fish, animals, and plants



### Fountain Scale Free

#98907

- Safely removes calcium and scale from water features
- Helps keep water clean and clear of hard water deposits, white scale, and foam
- Adds the fresh clean scent of lavender
- Safe for fish, animals, and plants

PRODUCT NUMBER	40004	98908	96055	40007	96056	98907
PACKAGE SIZE	36 Tabs	8 oz. / 236 ml	32 oz. / 946 ml	8 oz. / 236 ml	16 oz. / 473 ml	8 oz. / 236 ml
PACKAGED WEIGHT	.25 lb.	.75 lb.	2.5 lb.	.75 lb.	1.25 lb.	.75 lb.
1 TABLET TREATS	100 gal. / 378 L	—	—	—	—	—
1 CONTAINER TREATS	3,600 gal. / 13,608 L	—	—	—	—	—
1 PUMP TREATS	—	10 gal. / 37.8 L	—	10 gal. / 37.8 L	10 gal. / 37.8 L	10 gal. / 37.8 L
1 BOTTLE TREATS	—	500 gal. / 1,890 L	up to 300 sq. ft.	500 gal. / 1,890 L	1,000 gal. / 3,785 L	500 gal. / 1,890 L

## PROFESSIONAL GRADE WATER TREATMENTS

Aquascape professional grade water treatments are 25% more concentrated than the consumer equivalent. The graduated measuring cup allows larger doses to be easily applied.



### Beneficial Bacteria Professional Grade

#30406

Package Size: 1 gal. / 3.78 L  
 Packaged Weight: 8.75 lb.  
 1 scoop treats 6,000 gal. / 22,680 L  
 1 bottle treats 96,000 gal. / 362,880 L

- Provides clean, clear, and healthy water conditions
- Contains photosynthetic bacteria
- Contains marigold and vitamin B



### Beneficial Bacteria Concentrate Professional Grade

#30407

Package Size: 9 lb. / 4.08 kg  
 Packaged Weight: 9.5 lb.  
 1 scoop treats 48,000 gal. / 181,440 L  
 1 container treats 672,000 gal. / 2,540,160 L

- Provides clean, clear, and healthy water conditions
- Contains 8 strains of bacteria
- Contains photosynthetic bacteria



### Cold Water Beneficial Bacteria Professional Grade

#98895

Package Size: 1 gal. / 3.78 L  
 Packaged Weight: 9 lb.  
 1 scoop treats 6,000 gal. / 22,680 L  
 1 bottle treats 96,000 gal. / 362,880 L

- Provides clean, clear, and healthy water conditions
- Reduces ammonia, nitrite, and organic debris
- Ideal for use in water colder than 50°F (5°C)



### Pond Starter Bacteria Professional Grade

#40011

Package Size: 1 gal. / 3.78 L  
 Packaged Weight: 9 lb.  
 1 scoop treats 6,000 gal. / 22,712 L  
 1 bottle treats 96,000 gal. / 363,400 L

- Establishes biological ecosystem
- Great for spring start-up and new ponds



### Wetland Pond & Lake Bacteria Professional Grade

#98897

Package Size: 1 gal. / 3.78 L  
 Packaged Weight: 9 lb.  
 1 scoop treats 48,000 gal. / 181,440 L  
 1 bottle treats 768,000 gal. / 2,903,040 L

- Naturally reduces ammonia, nitrate, and excess nutrients
- Includes 8 pure strains of beneficial bacteria, including photosynthetic bacteria
- Maintains a balanced ecosystem



### Rapid Clear Flocculant Professional Grade

#30412

Package Size: 1 gal. / 3.78 L  
 Packaged Weight: 9 lb.  
 1 scoop treats 6,000 gal. / 22,712 L  
 1 bottle treats 96,000 gal. / 363,400 L

- Clears discolored or cloudy water
- Clumps suspended debris (flocculation)
- Clears most ponds in 24 hours



PROFESSIONAL GRADE WATER TREATMENTS



**Pond & Debris Clarifier Professional Grade**

#40010

Package Size: 1 gal. / 3.78 L  
 Packaged Weight: 9.5 lb.  
 1 scoop treats 6,000 gal. / 22,712 L  
 1 bottle treats 96,000 gal. / 363,400 L

- Quickly cleans unsightly debris
- Restores water quality
- Reduces pond maintenance



**SAB Stream & Pond Cleaner Professional Grade**

#30409

Package Size: 9 lb. / 4.08 kg  
 Packaged Weight: 9.5 lb.  
 1 scoop treats 3,000 gal. / 11,340 L  
 1 container treats 45,000 gal. / 170,000 L

- Keeps pond water clean and crystal clear
- Reduces pond maintenance
- Reduces ammonia and nitrates
- Phosphate binder



**Waterfall & Rock Cleaner Professional Grade**

#30413

Package Size: 9 lb. / 4.08 kg  
 Packaged Weight: 9.5 lb.  
 1 scoop treats 151-200 sq. ft.  
 1 container treats 3,650 sq. ft.

- Spot treats the trouble areas on water features
- Quickly eliminates debris from waterfalls and rocks
- Reduces pond maintenance
- Goes to work instantly



**Barley Straw Extract Professional Grade**

#98906

Package Size: 1 gal. / 3.78 L  
 Packaged Weight: 9.75 lb.  
 1 scoop treats 6,000 gal. / 22,680 L  
 1 bottle treats 96,000 gal. / 362,880 L

- Natural way to clarify water
- Provides clear, clean pond conditions
- Starts working instantly
- Concentrated formulation with added enzymes



**Ammonia Neutralizer Professional Grade**

#40012

Package Size: 1 gal. / 3.78 L  
 Packaged Weight: 9 lb.  
 1 scoop treats 6,000 gal. / 22,680 L  
 1 bottle treats 96,000 gal. / 362,880 L

- Makes pond water safe for fish and plants
- Detoxifies chloramine in tap water
- Instantly neutralizes large concentrations of toxic ammonia



**Pond Detoxifier Professional Grade**

#30410

Package Size: 1 gal. / 3.78 L  
 Packaged Weight: 9.5 lb.  
 1 scoop treats 6,000 gal. / 22,712 L  
 1 bottle treats 96,000 gal. / 363,400 L

- Makes tap water safe for fish and plants
- Removes and detoxifies chlorine and chloramines
- Neutralizes ammonia
- Detoxifies and chelates copper and heavy metals

**Sludge & Filter Cleaner Professional Grade**

#30408

Package Size: 1 gal. / 3.78 L  
 Packaged Weight: 9.25 lb.  
 1 scoop treats 6,000 gal. / 22,712 L  
 1 bottle treats 96,000 gal. / 363,400 L

- Biological pond and filter cleaner
- Contains 5 strains of heterotrophic bacteria
- Contains marigold and humic acid



## LAKE AND LARGE POND TREATMENTS

Aquascape lake and large pond treatments are optimized specifically for larger bodies of water and can cause issues when used in smaller water features.



**Lake Bacteria Packs**  
**#40013, #40014, #40015**

- Restores the ecosystem, keeping water clean, clear, and healthy
- Easy-to-use water soluble packs make it easy to treat hard-to-reach areas
- Significantly reduces maintenance
- Fortified with prebiotics to enhance water quality



**Lake Bacteria**  
**#40016**

- Restores the ecosystem, keeping water clean, clear, and healthy
- Significantly reduces maintenance
- Fortified with prebiotics to enhance water quality

PRODUCT NUMBER	40013	40014	40015	40016
PACKAGE SIZE	24 Packs	48 Packs	192 Packs	1 gal.
PACKAGED WEIGHT	.75 lb.	1.25 lb.	2.5 lb.	9.25 lb.
FOUR PACKS TREAT	1/4 acre for 1 month	1/4 acre for 1 month	1/4 acre for 1 month	—
ONE CONTAINER TREATS	up to 1.5 acres	up to 3 acres	up to 12 acres	—
ONE GALLON TREATS	—	—	—	1/4 acre for 1-3 months



**Lake Sludge Remover Packs**  
**#40017, #40018, #40019**

- Quickly eliminates organic sludge and muck
- Easy-to-use water soluble packs make it easy to spot treat and treat hard-to-reach areas
- All active ingredients with no fillers or binders
- Slowly releases oxygen to maximize sludge reduction
- Added macrobiotics and carbon source

PRODUCT NUMBER	40017	40018	40019
PACKAGE SIZE	192 Packs	384 Packs	1,152 Packs
PACKAGED WEIGHT	4.75 lb.	9.5 lb.	37 lb.
ONE PACK TREAT	250 ft. <sup>2</sup>	250 ft. <sup>2</sup>	250 ft. <sup>2</sup>
ONE CONTAINER TREATS	48,000 ft. <sup>2</sup>	96,000 ft. <sup>2</sup>	288,000 ft. <sup>2</sup>

## LAKE AND LARGE POND TREATMENTS



### Lake Blue Dye Packs

**#40020, #40021, #40022**

- Shades and protects water to prevent/eliminate water quality issues
- Easy-to-use water soluble packs make it easy to treat hard-to-reach areas
- Significantly reduces maintenance, filters sunlight, and cools water temperature
- Helps hide fish from predators



### Lake Flocculant Clarifier

**#40023**

- Quickly clears cloudy water caused by suspended particles
- Optimized to clarify clay, mineral material, and sediment issues
- Significantly reduces maintenance

PRODUCT NUMBER	40020	40021	40022	40023
PACKAGE SIZE	2 Packs	4 Packs	16 Packs	1 gal.
PACKAGED WEIGHT	.75 lb.	1.25 lb.	2.5 lb.	9.25 lb.
ONE PACK TREATS	1/4 acre for 1 month	1/4 acre for 1 month	1/4 acre for 1 month	—
ONE CONTAINER TREATS	up to 1.5 acres	up to 3 acres	up to 12 acres	—
ONE GALLON TREATS	—	—	—	1/4 acre for 1-3 months



### Lake Phosphate Binder Packs

**#40024, #40025, #40026**

- Quickly binds phosphates to clean and clear water
- Easy-to-use water soluble packs make it easy to treat hard-to-reach areas
- Prevents and eliminates floating debris and debris that attaches to rocks and gravel
- Significantly reduces maintenance
- Binds orthophosphate



### Lake Treatment Booster Packs

**#40027, #40028, #40029**

- Turbo boost the effects of all lake treatments
- Easy-to-use water soluble packs make it easy to treat hard-to-reach areas
- Adds oxygen directly to the water to accelerate nutrient uptake and sludge digestion
- Increases bacterial growth by up to ten times
- Great for non-aerated or highly eutrophic bodies of water

PRODUCT NUMBER	40024	40025	40026	40027	40028	40029
PACKAGE SIZE	192 Packs	384 Packs	1,152 Packs	192 Packs	384 Packs	1,152 Packs
PACKAGED WEIGHT	5 lb.	9.25 lb.	29 lb.	4.75 lb.	9.5 lb.	27.75 lb.
ONE PACK TREATS	250 ft. <sup>2</sup>	250 ft. <sup>2</sup>	250 ft. <sup>2</sup>	250 ft. <sup>2</sup>	250 ft. <sup>2</sup>	250 ft. <sup>2</sup>
ONE CONTAINER TREATS	48,000 ft. <sup>2</sup>	96,000 ft. <sup>2</sup>	288,000 ft. <sup>2</sup>	48,000 ft. <sup>2</sup>	96,000 ft. <sup>2</sup>	288,000 ft. <sup>2</sup>



**Pond fish can be vulnerable to a variety of predators**, including large birds such as the pesky blue heron. Fortunately, Aquascape provides several products to help pond owners prevent predators from harming their prized fish. Our popular ornamental deterrents help keep koi and other pond fish safe.

## PREDATOR CONTROL



### Floating Swan Decoy

#74014

Packaged Weight: 5 lb.  
 Dimensions: 31"L x 15"W x 18"H  
 Packaged Dimensions: 31.25"L x 14.75"W x 9.25"H

Deter geese, heron, and more with the realistic Floating Swan Decoy.

- Realistic mute swan decoy with lifelike appearance
- Durable and lightweight polyresin construction



### Floating Alligator Decoy

#93000

Packaged Weight: 2.5 lb.  
 Dimensions: 34"L x 6"W x 4"H  
 Packaged Dimensions: 11.5"L x 7.5"W x 10"H

Add a little fun to your pond while protecting your valuable fish. The natural body movement will deter herons and other predators from visiting your pond.

- Three hinged body parts allow gator to float freely and appear life-like, deterring pond predators
- Detailed in non-fading, no-glare, all-weather paint



### Blue Heron Decoy

#81030

Packaged Weight: 2.25 lb.  
 Dimensions: 28"L x 9"W x 6.25"H  
 Packaged Dimensions: 28"L x 9"W x 6.25"H

Deter herons from coming to your pond by tricking them into thinking another heron is already there.

- Looks life-like
- Quick and easy set-up
- Hand-painted with non-fading, no-glare, all-weather paint
- Surface treated to prevent paint flaking
- Molded from durable, lightweight polymer



### Faux Log Fish Cave

#78324

Packaged Weight: 11.5 lb.  
 Dimensions: 19"L x 12"W x 10"H  
 Packaged Dimensions: 22"L x 15"W x 13"H

- Provides pond fish shelter from predators
- Extremely realistic decorative accent for any size pond



**Aquascape ecosystem ponds are naturally balanced** and require very little care. You can easily maintain the health of your pond throughout the year with our comprehensive line of seasonal products.

## POND THERMOMETERS

Monitor pond temperature throughout the year with Aquascape pond thermometers. Use the accurate temperature data to adjust fish feeding schedules, change water treatments, and more. The specially designed Aquascape Smart Pond Thermometer is easy to connect to your smartphone or tablet, allowing you to easily check the temperature of your pond or water feature using the Aquascape Smart Control App.

Monitor water temperature with your smartphone or tablet



Smart Pond Thermometer

#74012

Packaged Weight: 1 lb.  
Packaged Dimensions: 5.5"L x 2.55"W x 5.7"H



Smart Pond Thermometer with Transformer

#74013

Packaged Weight: 1.5 lb.  
Packaged Dimensions: 5.5"L x 2.55"W x 5.7"H



### FEATURES OF THE SMART POND THERMOMETER

1. Integrated **hang tab** for quick, low-profile mounting
2. Integrated **display panel** for use without smartphone or tablet
3. **Numeric temperature indicator** displays current temperature in F or C
4. Weather-proof, **quick-connect connection**
5. **Removable cover** for quick and easy maintenance
6. **Black color and weighted base** allow for quick and discrete placement
7. **WiFi pairing button/indicator** allows for quick and easy connection to your smart phone or tablet
8. 3 ft **power cord**
9. 20 ft **probe cord**



Submersible Pond Thermometer

#74000

Packaged Weight: .25 lb.  
Packaged Dimensions: 5"L x 9"W x 1"H

Monitor pond temperature throughout the year to adjust fish feeding and water treatment applications during seasonal changes.

### APPLICATION

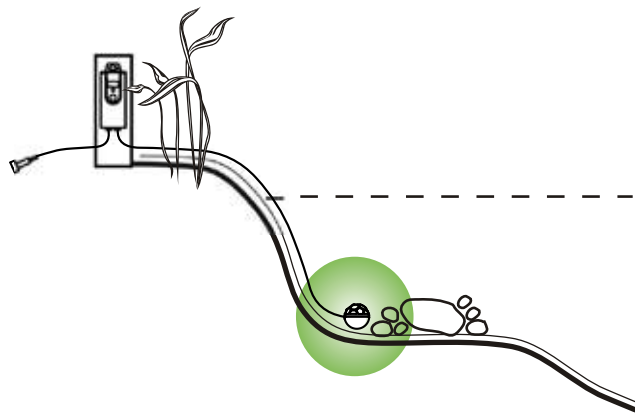

## SMART POND THERMOMETER

Give yourself peace of mind and eliminate guesswork by using accurate, real time temperature data to help manage your pond throughout the changing seasons. Receive friendly notifications on your smart phone when water temperature is ideal to start feeding your fish in the spring, switch to Cold Water Fish Food, and even change to Cold Water Beneficial Bacteria.



### Spring



### Summer



#### Cold Water Beneficial Bacteria

For more information, see page 88.



#### Premium Cold Water Fish Food Pellets

For more information, see page 108.



#### Pond Aeration Kits

For more information, see page 61.



#### Premium Staple Fish Food Pellets

For more information, see page 108.



#### Pond Starter Bacteria

For more information, see page 89.



#### Pond Detoxifier

For more information, see page 91.

### Fall



### Winter



#### Cold Water Beneficial Bacteria

For more information, see page 88.



#### Premium Cold Water Fish Food Pellets

For more information, see page 108.



#### Pond Powerhead

For more information, see page 55.



#### AquaForce® Solids-Handling Pond Pumps

For more information, see page 52.



#### Protective Pond Netting

For more information, see page 105.



#### 300-Watt Pond De-Icer

For more information, see page 105.



#### Pro Air Pond Aeration Kits

For more information, see page 62.



## POND DE-ICER

### 300-Watt Pond De-Icer

#39000



Packaged Weight: 4.5 lb.

Packaged Dimensions: 9"L x 9"W x 7"H

AquaScape 300-Watt Pond De-Icer is ideal for keeping a small opening in the ice during cold winter months to ensure proper gas exchange and help keep fish alive. The stainless steel construction prevents corrosion and cracking while the built-in LED light indicates when in use.



#### FEATURES OF THE POND DE-ICER

1. High quality **stainless steel housing**
2. **LED light** indicates when the unit is operating

## PROTECTIVE POND NETTING



### Protective Pond Netting

7' x 10'

#98000

Packaged Weight: .75 lb.

Packaged Dimensions: 5.5"L x 3"W x 9"H

### Protective Pond Netting

14' x 20'

#98001

Packaged Weight: 1.1 lb.

Packaged Dimensions: 7.25"L x 4.75"W x 15"H

### Protective Pond Netting

28' x 30'

#98002

Packaged Weight: 2.5 lb.

Packaged Dimensions: 10.5"L x 5"W x 21.5"H



### Bulk Protective Pond Netting

10' x 100'

#74007

Packaged Weight: 8 lb.

Packaged Dimensions: 20"L x 18"W x 10"H

### Bulk Protective Pond Netting

20' x 100'

#74002

Packaged Weight: 14.5 lb.

Packaged Dimensions: 20"L x 18"W x 13"H

### Bulk Protective Pond Netting

30' x 100'

#74003

Packaged Weight: 20.5 lb.

Packaged Dimensions: 21"L x 23"W x 18"H



### U-Shaped Ground Stakes

100 pieces

#74008

Packaged Weight: 1.5 lb.

Packaged Dimensions: 7"L x 1.5"W x 8"H



**Keep your fish happy and healthy** with Aquascape koi and pond fish care products. From fish food to fish treatments and pond nets, you'll find what you need to care for your finned friends.



# Did You Know

## **Aquascape fish foods not only support the health of your fish, they support the health of your ecosystem pond!**

Our specially-formulated fish food provides pond fish the best possible nutrition while reducing waste and pond maintenance.

- Contain prebiotics that help produce good bacteria to aid in digestion while helping to eliminate bad bacteria that may cause digestion issues and other long-term health problems
- Contain probiotics that aid in digestion helping to increase growth rates and reduce waste from fish that can negatively affect water quality
- Formulated with multivitamins and stabilized vitamin C to help boost the fish's immune system and prevent disease
- Made with high quality protein derived from whole fish, including anchovy, and mackerel

FISH FOOD



**Premium Staple Fish Food Pellets**

Formulated for everyday use when water temperatures are above 60°.

PREMIUM STAPLE FISH FOOD PELLETS			
ITEM NUMBER	WEIGHT	PELLET SIZE	RECOMMENDATION
98867	1.1 lb. / 500 g	Small	Ideal for fish from 3" (8 cm) and above
98868	2.25 lb. / 1 kg	Small	Ideal for fish from 3" (8 cm) and above
98869	4.4 lb. / 2 kg	Large	Ideal for fish from 8" (20 cm) and above
81049	11 lb. / 5 kg	Large	Ideal for fish from 8" (20 cm) and above
81007	22 lb. / 10 kg	Large	Ideal for fish from 8" (20 cm) and above
50003	44 lb. / 20 kg	Large	Ideal for fish from 8" (20 cm) and above
81050	1.1 lb. / 500 g	Mixed	Ideal for all size fish
81051	2.25 lb. / 1 kg	Mixed	Ideal for all size fish
81052	4.4 lb. / 2 kg	Mixed	Ideal for all size fish
81053	11 lb. / 5 kg	Mixed	Ideal for all size fish



**Premium Color Enhancing Fish Food Pellets**

Formulated to promote brilliant colors for all pond fish. Use when water temperatures are above 60°.

PREMIUM COLOR ENHANCING FISH FOOD PELLETS			
ITEM NUMBER	WEIGHT	PELLET SIZE	RECOMMENDATION
98873	1.1 lb. / 500 g	Small	Ideal for small fish from 3" (8 cm) and above
98874	2.25 lb. / 1 kg	Small	Ideal for small fish from 3" (8 cm) and above
98875	4.4 lb. / 2 kg	Large	Ideal for large fish from 8" (20 cm) and above
81048	11 lb. / 5 kg	Large	Ideal for large fish from 8" (20 cm) and above
81005	22 lb. / 10 kg	Large	Ideal for large fish from 8" (20 cm) and above
81006	44 lb. / 20 kg	Large	Ideal for large fish from 8" (20 cm) and above



**Premium Cold Water Fish Food Pellets**

Formulated to be fed at temperatures as low as 50°F/10°C.

PREMIUM COLD WATER FISH FOOD PELLETS			
ITEM NUMBER	WEIGHT	PELLET SIZE	RECOMMENDATION
98870	1.1 lb. / 500 g	Small	Ideal for small fish from 3" (8 cm) and above
98871	2.25 lb. / 1 kg	Small	Ideal for small fish from 3" (8 cm) and above
98872	4.4 lb. / 2 kg	Large	Ideal for large fish from 8" (20 cm) and above
81047	11 lb. / 5 kg	Large	Ideal for large fish from 8" (20 cm) and above
81003	22 lb. / 10 kg	Large	Ideal for large fish from 8" (20 cm) and above
81004	44 lb. / 20 kg	Large	Ideal for large fish from 8" (20 cm) and above

## FISH FOOD



### Premium Fish Food Flakes

4.2 oz. / 119 g

#98878

Packaged Weight: .5 lb.

Packaged Dimensions: 3.5"L x 3.5"W x 7.5"H

Aquascape Premium Fish Food Flakes are scientifically formulated to provide premium nutrition to all pond fish including goldfish and koi. The inclusion of plankton and shrimp meal help make this food irresistible to pond fish, including smaller fish and babies known as fry.

- Includes stabilized multivitamin
- Will not break apart and cloud water
- Contains high-quality protein
- Promotes brilliant colors on all pond fish



### Koi Krunchies

1.1 lb. / 400 g

#81000

Packaged Weight 1.25 lb.

Packaged Dimensions: 6"L x 6"W x 10"H

Aquascape Koi Krunchies are a wonderful addition to your fish's regular diet and are ideal for hand feeding goldfish, koi, and other pond fish. Aquascape Koi Krunchies contain real fruit flavors and are a great source of vitamin C, which is linked to proper tissue formation, proper digestion, and disease resistance.

- Great for hand feeding all pond fish
- Contains quality, natural ingredients

FISH TREATMENTS



**Ulcer & Bacterial Treatment**  
8.8 oz. / 250 g

#81038

Packaged Weight: .5 lb.  
1 scoop treats 125 gal / 472 L  
1 container treats 4,875 gal / 18,472 L

Ulcer & Bacterial Treatment treats bacterial infections, fin rot, open sores, and ulcers. Common symptoms include open wounds, fin rot, or bulging eyes. Treat fish as soon as you identify an issue.



**Praziquantel Treatment**  
8 oz. / 236 ml

#81041

Packaged Weight: .5 lb.  
5 ml treats 25 gal / 94 L  
1 bottle treats 1,250 gal / 4,725 L

Praziquantel Treatment treats external parasites, including flukes, flatworms, and tapeworms. Common symptoms include flashing/rubbing on rocks, white spots, or red/swollen gills. Treat fish as soon as you identify an issue.



**Fungus Treatment**  
8 oz. / 236 ml

#81040

Packaged Weight: .5 lb.  
5 ml treats 25 gal / 94 L  
1 bottle treats 1,250 gal / 4,725 L

Fungus Treatment treats fungal infections. Common symptoms include cottony-looking growths developing on pond fish. Treat fish as soon as you identify an issue.



**Parasite & Ich Treatment**  
8 oz. / 236 ml

#81039

Packaged Weight: .75 lb.  
5 ml treats 25 gal / 94 L  
1 bottle treats 1,250 gal / 4,725 L

Parasite & Ich Treatment treats external protozoan parasites. Common symptoms include flashing/rubbing on rocks, white spots, or red/swollen gills. Treat fish as soon as you identify an issue.

POND SALT

Aquascape Pond Salt reduces the effects of nitrite levels toxic to fish. This treatment helps restore natural electrolytes and repairs natural slime coat. Pond Salt prevents disease in fish.



**Pond Salt**  
2 lb. / 0.9 kg

#99416

Packaged Weight: 2.25 lb.  
1 scoop treats 190 gal / 718 L  
1 container treats up to 1,520 gal / 5,745 L

**Pond Salt**  
9 lb. / 4.08 kg

#99417

Packaged Weight: 10 lb.  
1 scoop treats 190 gal / 718 L  
1 container treats up to 6,840 gal / 25,835 L

**Pond Salt**  
40 lb. / 18.16 kg

#40003

Packaged Weight: 41.5 lb.  
1 scoop treats 190 gal / 718 L  
1 container treats up to 30,400 gal / 114,912 L

## POND SKIMMER NETS FOR FINE DEBRIS



**Pond Skimmer Net  
with Extendable Handle**

**#98559**

Packaged Weight: .75 lb.  
12"L x 7"W x 32" Handle, Extends to 63"

Great for scooping up debris in tight spaces



**Heavy Duty Pond Skimmer Net  
with Extendable Handle**

**#98562**

Packaged Weight: 1.4 lb.  
15"L x 15"W x 36" Handle, Extends to 63"

For removing large amounts of debris



**Professional Grade  
Pond Skimmer Net**

**#50001**

Packaged Weight: 2 lb.  
23"L x 20.5"W Net with 40" Handle

For removing large amounts of debris

## POND NETS FOR FISH AND GENERAL MAINTENANCE



**Koi Sock Net**

**#81057**

Packaged Weight: 1.2 lb.  
24"L x 13"W x 38.5"D with 8" Handle

Specially designed to safely transfer and handle pond fish, including koi and ornamental goldfish

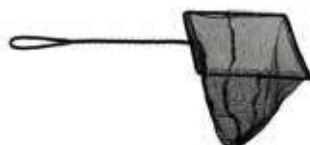

**Kid's Pond Explorer Net**

**#98556**

Packaged Weight: .2 lb.  
10"L x 7"W x 12" Handle

Provides a fun way to interact with ponds



**Professional Grade Pond Net**

**#50000**

Packaged Weight: 2 lb.  
23"L x 20.5"W Net with 40" Handle

For general maintenance, and handling large fish

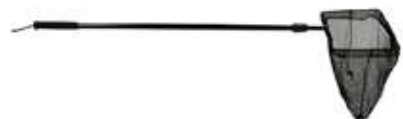

**Pond Net  
with Extendable Handle**

**#98558**

Packaged Weight: .75 lb.  
12"L x 7"W x 32" Handle, Extends to 63"

For general maintenance and handling pond fish



**Heavy Duty Pond Net  
with Extendable Handle**

**#98560**

Packaged Weight: 1.4 lb.  
15"L x 15"W x 36" Handle, Extends to 69"

For general maintenance, and handling pond fish



**Professional Fish Net  
with Extendable Handle**

**#98561**

Packaged Weight: 2.1 lb.  
22" Diameter Head, 32" Handle, Extends to 69"

For handling and cradling larger pond fish, preventing them from being snagged in mesh

## MULTI-PURPOSE NETS



**Pond Shark**

**#74004**

Packaged Weight: 2.1 lb.  
12"L x 8"W x 12"D, Extends up to 60"

Combines three helpful tools into one easy-to-use net for raking, scraping, and collecting algae and debris

- For general handling of pond fish



**Pond Shark Pro**

**#74005**

Packaged Weight: 2.1 lb.  
12"L x 8"W x 12"D, Extends up to 96"

Combines three helpful tools into one easy-to-use net for raking, scraping, and collecting algae and debris

- For general handling of pond fish



**Aquatic plants** are an important part of the water garden. They provide beauty and naturalization with a huge array of plant choices. Most importantly, they help balance the pond's ecosystem and provide valuable biological filtration that removes nitrogen, ammonia, nitrates, and other minerals from pond water. These excess nutrients are often the cause of unsightly water conditions. The end result helps to minimize pond maintenance, leaving more time to enjoy your pond. Without aquatic plants, your pond would not be able to function as a complete ecosystem.



## AQUATIC PLANTERS

Aquascape Aquatic Planters are ideal for all pond plants. Made from fine, porous material, the planters allow water in while preventing soil from entering your pond. The flexibility of Aquatic Planters makes it simple to place plants between rocks and other form-fitting areas. Aquatic Planters blend into their surroundings and will not break or crack like traditional plastic planters.



#98500 shown

### Aquatic Planter - 6" x 6" (2-pack)

**#98501**

Packaged Weight: .25 lb.  
Dimensions: 6" diameter x 6"H  
Packaged Dimensions: 6.5"L x 7"W x 1"H

### Aquatic Planter - 12" x 8" (2-pack)

**#98500**

Packaged Weight: .5 lb.  
Dimensions: 12" diameter x 8"H  
Packaged Dimensions: 12"L x 8"W x .5"H

### Aquatic Planter - 8" x 6" (2-pack)

**#98502**

Packaged Weight: .25 lb.  
Dimensions: 8" diameter x 6"H  
Packaged Dimensions: 11.5"L x 8"W x 1"H

### Aquatic Lily Planter - 14" x 7" (2-pack)

**#98929**

Packaged Weight: .5 lb.  
Dimensions: 14" diameter x 7"H  
Packaged Dimensions: 12"L x 9.5"W x 1"H

## FLOATING PLANT ISLAND

The Aquascape Floating Plant Island is ideal for displaying plants in deeper areas of the pond or where there are no plant shelves. The floating planter is constructed to stay afloat at the surface of the pond and keeps the soil intact and lets water in while protecting plants from fish.



### Floating Plant Island

**#89006**

Packaged Weight: .5 lb.  
Dimensions: 15"L x 11"W x 4"H  
Packaged Dimensions: 16"L x 4"W x 12.5"H

## POND PLANT POTTING MEDIA

This all-natural, non-toxic alluvial planting media is fine-grained and perfect for supporting the growth of aquatic plants. Our premium potting media contains no peat moss or compost and is safe for fish.



### Pond Plant Potting Media

215 cubic inches / 0.0035 cubic meters

**#89002**

### Pond Plant Potting Media

432 cubic in / 0.007 cubic meters

**#89003**



**Decorative features** are a unique, beautiful, and easy way to add a splash of water or a flash of fire to your outdoor living spaces. Aquascape fountains, fire features, and container water gardens are available in a variety of styles and sizes and can be installed quickly and easily. If you love the sound of water in the garden or enjoy the flicker of fire to warm your nights, Aquascape features are the perfect addition to any space.

MELT THE STRESS AWAY



## AQUASCAPE AUTO-IGNITE FIRE FEATURES

*Featuring The Flame Control System*

Aquascape auto-ignite fire features include an innovative control system with push-button ignition and easy flame height adjustment.



## AUTO-IGNITE FIRE FEATURES

Melt the stress away and excite your senses with these complete, turn-key, auto-ignite fire features. Each kit includes the Auto-Ignite Flame Control System with push button ignition and flame control for a safe and easy to install design. Top the burner with your desired fire media (not included, see page 119).



**Fire and Water Stacked Slate Urn - Large**

#58114

Packaged Weight: 203 lb.  
 Feature Dimensions: 35.5"L x 35.5"W x 55"H  
 Packaged Dimensions: 38"L x 37.8"W x 34.6"H

**Recommended Pump:**

Ultra 2000 Water Pump #91010

**Includes:** fire and water feature, control system, gas tubing, power cables, water tubing, and propane tank regulator

- Durable fiber-resin composite fire and water feature



**Faux Stone Fire Pit**

#58091

Packaged Weight: 175.5 lb.  
 Feature Dimensions: 41.5"L x 34.25"W x 14.25"H  
 Packaged Dimensions: 43.5"L x 35.5"W x 15.75"H

**Includes:** fire pit, control system, gas tubing, power cables, and propane tank regulator

- Durable, handcrafted, GFRC fire feature



**Fire and Water Spillway Bowl**

#58092

Packaged Weight: 73 lb.  
 Feature Dimensions: 34"L x 32"W x 15"H  
 Packaged Dimensions: 35"L x 35"W x 17.5"H

**Recommended Pump:**

Ultra 2000 Water Pump #91010

**Includes:** fire and water feature, control system, gas tubing, power cables, water tubing, and propane tank regulator

- Durable fiber-resin composite fire and water feature



**Fire and Water Stacked Slate Sphere - Medium**

#58093

Packaged Weight: 127.75 lb.  
 Feature Dimensions: 32" diameter x 24"H  
 Packaged Dimensions: 35"L x 35"W x 21.75"H

**Recommended Pump:**

Ultra 2000 Water Pump #91010

**Includes:** fire and water feature, control system, gas tubing, power cables, water tubing, and propane tank regulator

- Durable fiber-resin composite fire and water feature

## AUTO-IGNITE FLAME CONTROL SYSTEM

Aquascape auto-ignite fire features include an innovative control system with push-button ignition and easy flame height adjustment.



### FEATURES OF THE AUTO-IGNITE FLAME CONTROL SYSTEM

1. **Electronic ignition** starts fire with the push of the button
2. **Flame control knob** makes it easy to adjust flame height
3. Automatic flame-out, **shut-off valve** ensures safe operation
4. Integrated, **low-voltage battery** prevents the need to plug into a power source
5. 3/8" **flared connections** allow for easy installation of included gas tubing

## FIRE AND WATER BASALT COLUMN TORCHES

Enhance Aquascape basalt columns with the mesmerizing and therapeutic effects of fire! These innovative basalt column torches install quickly and easily into the top of Aquascape basalt columns. Choose from the Fire and Water 3-Piece Basalt Torch System or customize using a la carte components. The extremely simple design makes it easy to add fire to any existing basalt column!



Basalt columns sold separately, see page 122

### Fire and Water 3-Piece Basalt Torch System

#58103

Packaged Weight: 20 lb.

Packaged Dimensions: 18"L x 14"W x 14"H

**Recommended Pump:** Ultra 2000 Water Pump #91010

**Includes:** (3) torches with water tubing and rubber gas line, Match-Lit Flame Control System, gas tubing with splitter, and propane tank regulator

- Proprietary brass burner system combines fire and water into unique, impressive design



### Fire and Water Basalt Column Torch

#58101

**Recommended Pump:**

Ultra 2000 Water Pump #91010

**Includes:** water tubing— $\frac{1}{2}$ " x 6' and rubber gas hose— $\frac{1}{4}$ " x 6' with  $\frac{3}{8}$ " connection

- A la carte torch for custom installs
- Proprietary brass burner system combines fire and water into unique, impressive design



### Match-Lit Flame Control System

#58102

Packaged Weight: 12 lb.

Dimensions: 7.25"L x 7"W x 10"H

Packaged Dimensions: 15.75"L x 12"W x 10"H

**Includes:** integrated flame height adjustment and  $\frac{3}{8}$ " flare connections

- Makes it easy to control Aquascape Fire and Water Basalt Column Torches



### Rubber Gas Hose— $\frac{3}{8}$ " x 10'

#58111

### Rubber Gas Hose— $\frac{3}{8}$ " x 20'

#58112

### 4-Way $\frac{3}{8}$ " Splitter with Caps

#58109

### Propane Tank Regulator and Hose— $\frac{3}{8}$ " x 10'

#58104



Conceal propane tank easily with the Faux Stone Propane Tank Cover—see page 118



## PROPANE TANK COVERS

Conceal standard 20-pound propane tanks or other landscape components with these durable propane tank covers. Choose from realistic oak appearance, basalt stone, or one of our two contemporary styles.



**Faux Stone Propane Tank Cover**

**#78336**

Packaged Weight: 41.25 lb.  
 Dimensions: 16.5"L x 16.5"W x 21.25"H  
 Packaged Dimensions: 19.5"L x 19.5"W x 23.5"H

- Ideal for covering standard twenty-pound propane tanks and other components



**NEW**

**Round Propane Tank Cover - Gray**

**#78353**

Packaged Weight: 34.9 lb.  
 Dimensions: 16"L x 16"W x 20"H  
 Packaged Dimensions: 18.11"L x 18.11"W x 22.8"H

- Conceal standard propane tanks or other landscape components with this durable, GFRC cover with contemporary, smooth gray design.



**NEW**

**Square Propane Tank Cover - Travertine**

**#78354**

Packaged Weight: 34.9 lb.  
 Dimensions: 16"L x 16"W x 20"H  
 Packaged Dimensions: 18.11"L x 18.11"W x 22.8"H

- Conceal standard propane tanks or other landscape components with this durable, GFRC cover with elegant travertine finish and texture.



**NEW**

**Faux Stump Propane Tank Cover**

**#78345**

Packaged Weight: 14 lb.  
 Dimensions: 15"L x 15"W x 18"H  
 Packaged Dimensions: 17.5"L x 17.5"W x 21"H

- Conceal standard propane tanks or other landscape components with this lightweight and durable faux stump cover with extremely realistic oak appearance.



**NEW**

**Stainless Steel Fire Pan Cover - 20"**

**#58115**

Packaged Weight: 5.25 lb.  
 Dimensions: 20.25" Diameter x 1.75"H  
 Packaged Dimensions: 21"L x 24"W x 2.5"H

- Makes it easy to cover fire burners on Aquascape Auto-Ignite Fire Features, protecting burner components from the elements, such as snow and rain.

## FIRE MEDIA

Enhance your fire or water feature with Aquascape Tumbled Lava Stones. The rolled, smooth lava stones boast an attractive black and gray speckled appearance and are superior for use in gas fire burner systems and atop water feature basins alike. Fire glass is great for use in our auto-ignite fire features.



**Medium Tumbled Lava Stones**

25 lb.

**#78316**

- Stones measure 1-2" in diameter
- 1 bag covers approximately 1.5 square surface feet



**Large Tumbled Lava Stones**

25 lb.

**#78317**

- Stones measure 2-3" in diameter
- 1 bag covers approximately 1.5 square surface feet



**Mixed Tumbled Lava Stones**

50 lb.

**#78318**

- Includes one bag of Medium and one bag of Large Tumbled Lava Stones
- 1 bag covers approximately 1.5 square surface feet



**1/4" Reflective Black Fire Glass**

10.5 lb.

**#78262**



**1/4" Reflective Cobalt Blue Fire Glass**

10.5 lb.

**#78263**



**1/4" Aquamarine Fire Glass**

10.5 lb.

**#78264**

## FIRE FOUNTAIN

The Aquascape Fire Fountain provides the beauty and elegance of fire and flowing water in a GFRC (glass fiber reinforced concrete) water feature. The self-contained water feature is a complete kit and sets up in minutes. Paraffin oil recommended (not included). Fire Glass sold separately.



Shown with Reflective Cobalt Blue Fire Glass (sold separately)

**Fire Fountain 24"**

**#78201**

Packaged Weight: 56 lb.  
Dimensions: 24" diameter x 12"H  
Packaged Dimensions: 26.5"L x 26.5"W x 14"H



#78202 shown

**Fire Fountain 28"**

**#78202**

Packaged Weight: 72 lb.  
Dimensions: 28" diameter x 14"H  
Packaged Dimensions: 30.5"L x 30.5"W x 17"H

**Fire Fountain 32"**

**#78203**

Packaged Weight: 96 lb.  
Dimensions: 32" diameter x 16"H  
Packaged Dimensions: 34.5"L x 34.5"W x 18.25"H

## WATER FEATURE BASINS

Aquascape AquaBasins® are engineered to provide a trouble-free, easy-to-install fountain basin for a wide variety of decorative water feature installations, including natural stone, brass, and resin fountains. Their innovative design provides features and benefits that eliminate guesswork, improve water circulation, increase accessibility, and ensure a lifetime of enjoyment.



**AquaBasin® 45**  
#78224



**AquaBasin® 30**  
#78223



**DecoBasin**  
#60000

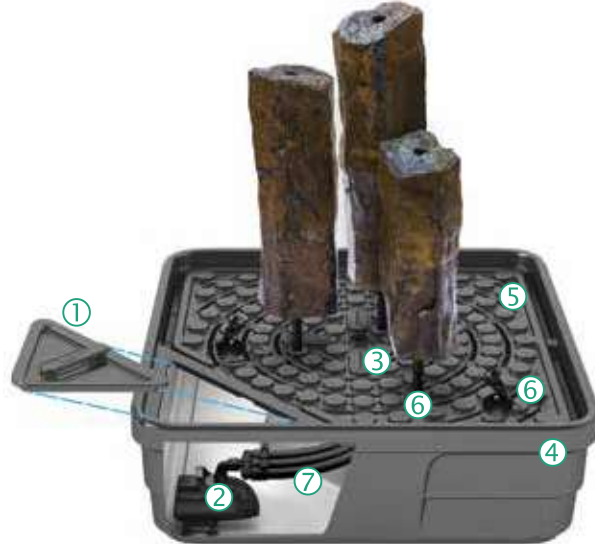

### FEATURES OF THE AQUABASIN® 45 AND 30

1. Large corner **pump access** panel fits larger pumps and sits elevated to prevent gravel from falling into the basin
2. **Pump and valve controls** are easy to access for maintenance and adjusting water flow
3. Large, **flat deck** design makes it easy to set and position fountains
4. Professional-grade, high-density **polyethylene construction**
5. **Drainage slots** throughout the deck maximize water circulation
6. Structural **deck cylinders** provide endless plumbing and lighting port configurations, while reinforcing basin strength
7. Internal **plumbing support** allows plumbing to sit below the deck as it travels to the fountain(s), making installation simple and keeping plumbing out of sight

- 5" diameter pump access hole
- 54" splash skirt prevents leakage or over-splash

MODEL	AQUABASIN 30	AQUABASIN 45	DECOBASIN
WATER STORAGE CAPACITY	27 gal.	98 gal.	15 gal.
MAX FLOW RATE	2,000 GPH	4,000 GPH	1,500 GPH
DIMENSIONS	30"L x 30"W x 12"H	44.5"L x 44.5"W x 16"H	22" diameter x 14.25"H
WEIGHT CAPACITY	500 lb.	1,500 lb.	100 lb.
WARRANTY	Limited Lifetime	Limited Lifetime	1-Year
PACKAGED WEIGHT	22 lb.	60 lb.	9 lb.



## SPILLWAY BOWL, BASIN, AND STAND

The Aquascape Spillway Bowl, Basin, and Stand have a beautiful and unique patina made from durable GFRC (glass fiber reinforced concrete). They are easy to install in unlimited possibilities. Install them as a disappearing water feature or link several together for an inspired display. The stands create the ideal elevation between the bowl and basin.



**Spillway Basin 40"**

**#78205**

Packaged Weight: 119 lb.  
 Dimensions: 40"L x 40"W x 16"H  
**Recommended Pump:**  
 Ultra 2000 Water Pump #91010



**Spillway Bowl 32"**

**#78204**

Packaged Weight: 70.25 lb.  
 Dimensions: 32"L x 32"W x 14.5"H  
**Recommended Pump:**  
 Ultra 2000 Water Pump #91010



**Spillway Bowl Stand  
 (2-pack)**

**#78206**

Packaged Weight: 33.5 lb.  
 Dimensions: 13.5"L x 13.5"W x 4"H



**Spillway Bowl and Basin Landscape Fountain Kit**

**#58087**

Packaged Weight: 380 lb.

For more information, see page 23.



## STONE BASALT COLUMNS

These natural stones provide impressive sights and sounds as water tumbles from the tall columns. The amazing variation and texture options ensure there is a basalt column perfect for any location.

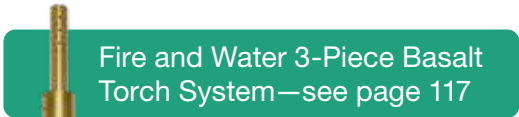

Fire and Water 3-Piece Basalt Torch System—see page 117

### Natural Mongolian Basalt Column 24"

#58038

Approx. Packaged Weight: 200 lb.  
Dimensions: 10" diameter x 24"H

**Recommended Pump:**  
Ultra 800 Water Pump #91007

### Natural Mongolian Basalt Column 30"

#98503

Approx. Packaged Weight: 335 lb.  
Dimensions: 10" diameter x 30"H

**Recommended Pump:**  
Ultra 800 Water Pump #91007

### Natural Mongolian Basalt Column 36"

#98969

Approx. Packaged Weight: 375 lb.  
Dimensions: 10" diameter x 36"H

**Recommended Pump:**  
Ultra 800 Water Pump #91007



### Natural Mongolian Basalt Columns Set of 3

#58062

Packaged Weight: 850 lb.  
**Includes:** (1)–24", (1)–30", and (1)–36"



### Mongolian Basalt Columns Set of 3 Landscape Fountain Kit

#58089

Approx. Packaged Weight: 970 lb.  
**For more information, see page 24.**



### Mongolian Basalt Column 30" Landscape Fountain Kit

#58065

Approx. Packaged Weight: 388 lb.  
**For more information, see page 24.**



### Double-Textured Basalt Columns Set of 3

#98548

Packaged Weight: 276 lb.  
**Includes:**  
(1)–9" diameter x 20"H  
(1)–7" diameter x 13"H  
(1)–8" diameter x 8"H  
**Recommended:**  
AquaBasin® 30 #78223  
Ultra 1100 Water Pump #91008  
Pre-Cut Kink-Free Pipe ¾" x 6' #98404



### Keyed Basalt Columns Set of 3

#98552

Packaged Weight: 246 lb.  
**Includes:**  
(1)–11" diameter x 18"H  
(1)–11" diameter x 12"H  
(1)–10" diameter x 6"H  
**Recommended:**  
AquaBasin® 30 #78223  
Ultra 400 Water Pump #91005  
Pre-Cut Kink-Free Pipe ¾" x 6' #98404



### Semi-Polished Stone Basalt Columns Set of 3

#98264

Packaged Weight: 289 lb.  
**Includes:**  
(1)–7.5" diameter x 12"H  
(1)–7.5" diameter x 20"H  
(1)–10" diameter x 27"H  
**Recommended:**  
AquaBasin® 45 #78224  
Ultra 2000 Water Pump #91010  
Pre-Cut Kink-Free Pipe ¾" x 6' #98404

## SCALLOPED URNS



### Small Scalloped Urn

**#78238**

Packaged Weight: 26 lb.  
 Dimensions: 20" diameter x 32"H  
**Recommended Pump:**  
 Ultra 550 Water Pump **#91006**

### Medium Scalloped Urn

**#78239**

Packaged Weight: 50 lb.  
 Dimensions: 27" diameter x 45"H  
**Recommended Pump:**  
 Ultra 1100 Water Pump **#91008**

### Large Scalloped Urn

**#78240**

Packaged Weight: 93 lb.  
 Dimensions: 38" diameter x 56"H  
**Recommended Pump:**  
 Ultra 2000 Water Pump **#91010**

Fire Fountain Add-On Kit for Scalloped Urns available—**#78260**



### Medium Scalloped Urn Landscape Fountain Kit

**#78270**

Packaged Weight: 145 lb.  
 For more information, see page 22.

## RIPPLED URNS



### Small Rippled Urn

**#78241**

Packaged Weight: 24.7 lb.  
 Dimensions: 20" diameter x 32"H  
**Recommended Pump:**  
 Ultra 550 Water Pump **#91006**

### Medium Rippled Urn

**#78242**

Packaged Weight: 42 lb.  
 Dimensions: 27" diameter x 45"H  
**Recommended Pump:**  
 Ultra 1100 Water Pump **#91008**

### Large Rippled Urn

**#78243**

Packaged Weight: 91 lb.  
 Dimensions: 38" diameter x 56"H  
**Recommended Pump:**  
 Ultra 2000 Water Pump **#91010**

Fire Fountain Add-On Kit for Rippled Urns available—**#78267**



### Medium Rippled Urn Landscape Fountain Kit

**#78271**

Packaged Weight: 164 lb.  
 For more information, see page 22.

## STACKED SLATE URNS



**Small Stacked Slate Urn**

**#98939**

Packaged Weight: 34.5 lb.  
 Dimensions: 20" diameter x 33.5"H  
**Recommended Pump:**  
 Ultra 550 Water Pump [#91006](#)

**Medium Stacked Slate Urn**

**#78207**

Packaged Weight: 56 lb.  
 Dimensions: 27" diameter x 45"H  
**Recommended Pump:**  
 Ultra 1100 Water Pump [#91008](#)

**Large Stacked Slate Urn**

**#98940**

Packaged Weight: 104 lb.  
 Dimensions: 35.5" diameter x 55"H  
**Recommended Pump:**  
 Ultra 2000 Water Pump [#91010](#)



**Small Stacked Slate Urn Fountain Kit**

**#58064**

Packaged Weight: 38 lb.  
**Kit Includes:**

- Small Stacked Slate Urn
- Tubing
- DecoBasin
- Ultra 550 Water Pump



**Medium Stacked Slate Urn  
 Landscape Fountain Kit**

**#58090**

Packaged Weight: 180 lb.  
 For more information, see page 22.

Fire Fountain Add-On Kit for Stacked  
 Slate Fountains available—[#78221](#)



## STACKED SLATE SPHERES



### Small Stacked Slate Sphere

**#78287**

Packaged Weight: 26 lb.  
 Dimensions: 24" diameter x 22"H  
**Recommended Pump:**  
 Ultra 800 Water Pump #91007

### Medium Stacked Slate Sphere

**#78288**

Packaged Weight: 68 lb.  
 Dimensions: 32" diameter x 30"H  
**Recommended Pump:**  
 Ultra 1500 Water Pump #91009

### Large Stacked Slate Sphere

**#78289**

Packaged Weight: 111 lb.  
 Dimensions: 40" diameter x 37.5"H  
**Recommended Pump:**  
 Ultra 2000 Water Pump #91010



Fire Fountain Add-On Kit not included



### Medium Stacked Slate Sphere Landscape Fountain Kit

**#78290**

Packaged Weight: 195 lb.  
**For more information, see page 22.**

Fire Fountain Add-On Kit for Stacked  
 Slate Fountains available—#78221



## CURVED STACKED SLATE WALL TOPPERS



**Front-Spill  
Curved Stacked Slate Topper**

**#78284**

Packaged Weight: 19.25 lb.  
Dimensions: 36"L x 12"W x 6"H



**Rear-Spill  
Curved Stacked Slate Topper**

**#78285**

Packaged Weight: 17.5 lb.  
Dimensions: 36"L x 12"W x 6"H



**Quad-Spill  
Curved Stacked Slate Topper**

**#78286**

Packaged Weight: 19.25 lb.  
Dimensions: 36"L x 12"W x 6"H

## CURVED STACKED SLATE WALL BASES



**Small Curved Stacked Slate Wall Base**

**#78283**

Packaged Weight: 22.75 lb.  
Dimensions: 36"L x 12"W x 13"H  
**Recommended Pump:**  
Ultra 2000 Water Pump [#91010](#)



**Large Curved Stacked Slate Wall Base**

**#78282**

Packaged Weight: 39 lb.  
Dimensions: 36"L x 12"W x 26"H  
**Recommended Pump:**  
Ultra 2000 Water Pump [#91010](#)



## STRAIGHT STACKED SLATE WALL TOPPERS



**Quad-Spill  
Straight Stacked Slate Topper**

**#78280**

Packaged Weight: 18.75 lb.  
Dimensions: 36"L x 12"W x 6"H



**Front-Spill  
Straight Stacked Slate Topper**

**#78281**

Packaged Weight: 18.75 lb.  
Dimensions: 36"L x 12"W x 6"H

## STRAIGHT STACKED SLATE WALL BASES



**Small Straight Stacked Slate Wall Base**

**#78279**

Packaged Weight: 24 lb.  
Dimensions: 36"L x 12"W x 13"H  
**Recommended Pump:**  
Ultra 2000 Water Pump [#91010](#)



**Large Straight Stacked Slate Wall Base**

**#78278**

Packaged Weight: 41 lb.  
Dimensions: 36"L x 12"W x 26"H  
**Recommended Pump:**  
Ultra 2000 Water Pump [#91010](#)



**Stacked Slate Spillway Wall 32"  
Landscape Fountain Kit**

**#78269**

Packaged Weight: 157 lb.  
For more information, see page 23.

## BACKYARD WATERFALL LANDSCAPE FOUNTAIN KIT

The Aquascape Backyard Waterfall Landscape Fountain Kit is the perfect, easy-to-install Pondless® Waterfall kit. This complete kit includes the necessary components to install the soothing sound of running water in almost any outdoor location. Perfect for smaller spaces, this kit is ideal for front yards or situated next to your patio. For more information, see page 18 and 19.



**Backyard Waterfall Landscape Fountain Kit**

**#83013**

Packaged Weight: 175 lb.

Packaged Dimensions: 48"L x 40"W x 35"H (Palletized)

For more information, see page 19.





## AQUATIC PATIO POND KIT

The Aquascape Aquatic Patio Pond Kit makes it easy to add the soothing sounds of water to any location. Use in your garden, on your deck, patio, or balcony, or take it inside and add the beauty of water to your desk, kitchen, or living room.



### Aquatic Patio Pond Kit

#78197

- Packaged Weight: 9 lb.  
 Packaged Dimensions: 19"L x 19"W x 10.5"H
- Kit Includes:**
- 16" Square Textured Gray Slate Patio Pond
  - Pouring bamboo fountain with pump

## PATIO PONDS

Aquascape Patio Ponds make it simple to have a complete water garden in almost any setting. Creating a beautifully planted container water garden has never been easier. Use outside in your outdoor living space or bring indoors to add the soothing sounds of water to any room. The durable, lightweight fiber-resin construction provides a realistic earthenware finish. The integrated plant shelf makes it easy to create a natural paradise with Aquascape Patio Ponds.



**Green Slate 24"**  
**Patio Pond**  
 10 gallons  
**#98853**

Packaged Weight: 28 lb.  
 Dimensions: 24"L x 24"W x 12"H



**Desert Granite 24"**  
**Patio Pond**  
 10 gallons  
**#98854**

Packaged Weight: 28 lb.  
 Dimensions: 24"L x 24"W x 12"H



**European Terra Cotta 24"**  
**Patio Pond**  
 10 gallons  
**#98855**

Packaged Weight: 28 lb.  
 Dimensions: 24"L x 24"W x 12"H



**Textured Gray Slate 22"**  
**Patio Pond**  
 15 gallons  
**#78049**

Packaged Weight: 28 lb.  
 Dimensions: 22"L x 22"W x 12"H

**Green Slate 32"**  
**Patio Pond**  
 20 gallons  
**#98856**

Packaged Weight: 43.5 lb.  
 Dimensions: 32"L x 32"W x 14"H

**Desert Granite 32"**  
**Patio Pond**  
 20 gallons  
**#98857**

Packaged Weight: 43.5 lb.  
 Dimensions: 32"L x 32"W x 14"H

**European Terra Cotta 32"**  
**Patio Pond**  
 20 gallons  
**#98858**

Packaged Weight: 43.5 lb.  
 Dimensions: 32"L x 32"W x 14"H

**Textured Gray Slate 27"**  
**Patio Pond**  
 27 gallons  
**#78050**

Packaged Weight: 43.5 lb.  
 Dimensions: 27"L x 27"W x 14"H

**Green Slate 40"**  
**Patio Pond**  
 30 gallons  
**#98859**

Packaged Weight: 51 lb.  
 Dimensions: 40"L x 40"W x 16"H

**Desert Granite 40"**  
**Patio Pond**  
 30 gallons  
**#98860**

Packaged Weight: 51 lb.  
 Dimensions: 40"L x 40"W x 16"H

**European Terra Cotta 40"**  
**Patio Pond**  
 30 gallons  
**#98861**

Packaged Weight: 51 lb.  
 Dimensions: 40"L x 40"W x 16"H

**Textured Gray Slate 33"**  
**Patio Pond**  
 45 gallons  
**#78051**

Packaged Weight: 34.5 lb.  
 Dimensions: 33"L x 33"W x 16"H

## AQUAGARDEN MINI POND KIT

Add a small pond and water garden to any outdoor or indoor location with the Aquascape AquaGarden Mini Pond Kit. This complete kit includes everything you need, simply add your favorite plants and watch them grow. Great plant additions to the upper water garden include houseplants, herbs, marginal plants, and more.



**AquaGarden Mini Pond Kit - Mocha**

#78325

Packaged Weight: 19 lb.  
Dimensions: 23.5" diameter x 9.875"H  
Packaged Dimensions: 24"L x 24"W x 14"H



**AquaGarden Mini Pond Kit - Gray**

#78333

Packaged Weight: 19 lb.  
Dimensions: 23.5" diameter x 9.875"H  
Packaged Dimensions: 24"L x 24"W x 14"H



**AquaGarden Plant Light**

#78332

Packaged Weight: 1 lb.  
Dimensions: 8"L x 3.75"W x 18.25"H  
Packaged Dimensions: 20.5"L x 9"W x 4.25"H

- Designed to illuminate the AquaGarden and grow plants indoors
- Great for use indoors or outdoors (outdoor rated)
- Low-voltage transformer included



**AquaGarden Stand**

#78331

Packaged Weight: 8.8 lb.  
Packaged Dimensions: 15"L x 14"W x 4.5"H

- Designed to elevate the AquaGarden Mini Pond Kit
- Measures 13.25" diameter x 16"H
- Durable, powder coated iron construction



### FEATURES OF THE AQUAGARDEN MINI POND KIT

1. Durable, **injection-molded container** is lightweight and built to last
2. Integrated **plant and waterfall filter** cleans water and houses plants
3. **Pump** with low-suction attachment maximizes water usage and circulation
4. Integrated **waterfall light** illuminates the waterfall
5. Expanded clay **grow media** provides an ideal environment for plant growth
6. **Decorative gravel** in upper waterfall weighs down and disguises the grow media
7. **Decorative gravel** in lower pond beautifies the pond and provides surface area for beneficial bacteria to help keep the water clean
8. **AquaGarden Plant Light** provides ideal light for growing plants indoors (sold separately)
9. Durable powder coated iron **AquaGarden Stand** (sold separately)

NEW

## AQUAGARDEN TABLETOP FOUNTAIN KIT

Add a compact water garden to any indoor location with the Aquascape AquaGarden Tabletop Fountain Kit. This complete kit includes everything you need to get started. The compact size makes it a great option for offices, kitchens, and other indoor locations.



**AquaGarden Tabletop Fountain Kit - Mocha**  
#78346

Packaged Weight: 5.25 lb.  
Dimensions: 11" diameter x 5"H  
Packaged Dimensions: 12.2"L x 12.2"W x 6.3"H



**AquaGarden Tabletop Fountain Kit - Gray**  
#78347

Packaged Weight: 5.25 lb.  
Dimensions: 11" diameter x 5"H  
Packaged Dimensions: 12.2"L x 12.2"W x 6.3"H



### FEATURES OF THE AQUAGARDEN TABLETOP FOUNTAIN KIT

1. Durable, **injection-molded container** is lightweight and built to last
2. **Plant and waterfall filter** with integrated pump cleans the water
3. Tranquil **waterfall spout with integrated LED waterfall light** provides soothing sights and sounds
4. **Overhead plant light** illuminates the AquaGarden while helping plants grow
5. Expanded clay **grow media** provides an ideal environment for plant growth
6. **Decorative gravel** in upper waterfall weighs down and disguises the grow media
7. **Decorative gravel** in lower pond beautifies the pond and provides surface area for beneficial bacteria to help keep the water clean

## BAMBOO FOUNTAINS

Aquascape bamboo spitters are made from high quality, sturdy, polyresin that is both lightweight and UV and heat resistant. Polyresin takes on the texture, shape, and finish of real bamboo at a fraction of the cost and maintenance.



**Deer Scarer  
Bamboo Fountain**

**#78306**

Packaged Weight: 4.25 lb.  
Dimensions: 5.5"L x 4"W x 14"H  
Packaged Dimensions: 18"L x 7"W x 8"H  
**Recommended:** 90 GPH Water Pump [#91024](#)



**Pouring 3-Tier  
Bamboo Fountain**

**#78307**

Packaged Weight: 3.25 lb.  
Dimensions: 5"L x 3.25"W x 15.5"H  
Packaged Dimensions: 18.5"L x 7.25"W x 7.5"H  
**Recommended:** 90 GPH Water Pump [#91024](#)



**Adjustable Pouring  
Bamboo Fountain**

**#78308**

Packaged Weight: 5.75 lb.  
Dimensions: 18-30"L x 4.5"W x 10"H  
Packaged Dimensions: 22.25"L x 7.5"W x 9"H  
**Recommended:** 90 GPH Water Pump [#91024](#)



## DECORATIVE SPITTERS

Aquascape decorative spitters are made from high-quality, sturdy, polyresin that is both lightweight and UV and heat resistant. Polyresin takes on the texture, shape, and finish of real brass, wood, and stone at a fraction of the cost and maintenance.



**Alligator Spitter**

**#78302**

Packaged Weight: 9.75 lb.  
Dimensions: 18"L x 11"W x 12"H  
Packaged Dimensions: 21.75"L x 14"W x 14"H  
**Recommended:** 180 GPH Water Pump [#91025](#)



**Dragonfly Spitter**

**#78303**

Packaged Weight: 14.5 lb.  
Dimensions: 15"L x 18"W x 24"H  
Packaged Dimensions: 27.5"L x 19.25"W x 14.5"H  
**Recommended:** 180 GPH Water Pump [#91025](#)



**Double Frog with Cattail Spitter**

**#78304**

Packaged Weight: 9.5 lb.  
Dimensions: 10"L x 8"W x 18"H  
Packaged Dimensions: 10"L x 10"W x 18"H  
**Recommended:** 180 GPH Water Pump [#91025](#)

DECORATIVE SPITTERS



Frog on Reed Spitter

#78305

Packaged Weight: 6.75 lb.  
 Dimensions: 14"L x 8.25"W x 18"H  
 Packaged Dimensions: 20"L x 17.5"W x 12"H  
**Recommended:** 180 GPH Water Pump #91025



Lazy Frog on Lily Pad Spitter

#78311

Packaged Weight: 4.25 lb.  
 Dimensions: 12"L x 10"W x 5"H  
 Packaged Dimensions: 13"L x 12"W x 7.5"H  
**Recommended:** 90 GPH Water Pump #91024



Naughty Dog Spitter

#78310

Packaged Weight: 8.5 lb.  
 Dimensions: 17"L x 12"W x 12.75"H  
 Packaged Dimensions: 20.5"L x 12"W x 12.75"H  
**Recommended:** 90 GPH Water Pump #91024



Crazy Legs Frog Spitter

#78312

Packaged Weight: 10 lb.  
 Dimensions: 37.5"L x 8"W x 12"H  
 Packaged Dimensions: 40"L x 11.5"W x 22"H  
**Recommended:** 90 GPH Water Pump #91024



Crane with Lowered Head Spitter

#78313

Packaged Weight: 17.25 lb.  
 Dimensions: 11"L x 17"W x 35"H  
 Packaged Dimensions: 22.5"L x 14.25"W x 37.5"H  
**Recommended:** 180 GPH Water Pump #91025



Standing Crane Spitter

#78314

Packaged Weight: 18.25 lb.  
 Dimensions: 10"L x 13"W x 41"H  
 Packaged Dimensions: 19.5"L x 14"W x 44"H  
**Recommended:** 180 GPH Water Pump #91025



Toucan Spitter

#78309

Packaged Weight: 10.25 lb.  
 Dimensions: 15"L x 9"W x 16"H  
 Packaged Dimensions: 19"L x 12.5"W x 19.5"H  
**Recommended:** 90 GPH Water Pump #91024



\* barrel not included

Man in Barrel Spitter

#78315

Packaged Weight: 3.75 lb.  
 Dimensions: 37.5"L x 8"W x 12"H  
 Package Dimensions: 12"L x 9"W x 14.5"H  
 Head Dimensions: 8.5"L x 11"W x 8"H  
 Hand Dimensions: 4.5"L x 5"W x 3"H  
**Recommended:** 90 GPH Water Pump #91024



DECORATIVE ACCESSORIES



Faux Driftwood 30"

#78276

Packaged Weight: 4.5 lb.  
Packaged Dimensions: 31.75"L x 7"W x 10.5"H

- Ideal for concealing hard-to-hide water feature components, such as skimmers and spillways
- Great for use as a decorative accent



Faux Driftwood 35"

#78277

Packaged Weight: 7.5 lb.  
Packaged Dimensions: 36"L x 8"W x 10.75"H

- Ideal for concealing hard-to-hide water feature components, such as skimmers and spillways
- Great for use as a decorative accent



Fountain Shims  
(set of 6)

#78159

Packaged Weight: .5 lb.  
Packaged Dimensions: 4"L x 1"W x 7"H

- Ideal for leveling resin, concrete, stone, or GFRC water fountains.



Decorative River Pebbles—Black

#78160

Packaged Weight: 22 lb.  
Packaged Dimensions: 9"L x 3.5"W x 14"H

- Each stone measures approximately 3 to 5" in size, each bag covers 1.5 square surface feet



Decorative River Pebbles—Mixed

#78161

Packaged Weight: 22 lb.  
Packaged Dimensions: 9"L x 3.5"W x 14"H

- Each stone measures approximately 3 to 5" in size, each bag covers 1.5 square surface feet



Medium Tumbled Lava Stones

25 lb.

#78316

- Stones measure 1-2" in diameter
- 1 bag covers approximately 1.5 square surface feet



Large Tumbled Lava Stones

25 lb.

#78317

- Stones measure 2-3" in diameter
- 1 bag covers approximately 1.5 square surface feet



Mixed Tumbled Lava Stones

50 lb.

#78318

- Includes one bag of Medium and one bag of Large Tumbled Lava Stones
- 1 bag covers approximately 1.5 square surface feet

DECORATIVE ACCESSORIES



Faux Oak Stump Cover

#78259

Packaged Weight: 19 lb.

Dimensions: 15" diameter x 18.5"H

Packaged Dimensions: 18"L x 18"W x 21"H

- Great for hiding outdoor electrical outlets
- Can also be used as a decorative garden accent or seat



Faux Log Fish Cave

#78324

Packaged Weight: 11.5 lb.

Dimensions: 19"L x 12"W x 10"H

Packaged Dimensions: 22"L x 15"W x 13"H

- Provides pond fish shelter from predators
- Extremely realistic decorative accent for any size pond



Smart Control Plug

#82001

Packaged Weight: .5 lb.

Dimensions: 6"L x 1.5"W x 5.5"H with a 6" cord

Packaged Dimensions: 7"L x 2"W x 6"H

For more information, see page 77.



Control Aquascape water features with your smartphone or tablet

# LINER, UNDERLAYMENT, AND GEOTEXTILE



**Liner, underlayment, and geotextile are the pond's foundation.** With a large selection of liners available, it is important to always determine whether the liner you choose is safe for fish that may inhabit the pond.



## 45 MIL EPDM LINER

Aquascape 45 mil fish-safe EPDM pond liner leads the industry in quality and reliability. Backed by an industry-leading 20-year guarantee, Aquascape pond liner is the choice of discerning pond professionals. With superior elongation and lay-flat characteristics, it installs easily with no special tools required. Aquascape 45 mil fish-safe EPDM pond liner also has exceptional resistance to solar UV, ozone, and oxidation.

36 MIL REINFORCED POLYPROPYLENE LINER		
ITEM NUMBER	ROLL DIMENSIONS	PACKAGED WEIGHT
30336	Special Order Only • Minimum Size of 60' x 100'	.185 lb. per sq. ft.

45 MIL EPDM LINER ROLLS*		
ITEM NUMBER	ROLL DIMENSIONS	PACKAGED WEIGHT
42002	5' x 100'	164 lb.
29188	10' x 50'	164 lb.
29189	10' x 100'	324 lb.
29192	15' x 50'	243 lb.
29193	15' x 100'	486 lb.
29196	20' x 50'	324 lb.
29197	20' x 100'	648 lb.
29200	25' x 50'	402 lb.
29201	25' x 100'	810 lb.
29202	30' x 50'	486 lb.
29203	30' x 100'	972 lb.
29206	40' x 50'	678 lb.
29207	40' x 100'	1,295 lb.
29210	50' x 50'	810 lb.
29211	50' x 100'	1,635 lb.

45 MIL EPDM BOXED LINER			
ITEM NUMBER	LINER DIMENSIONS	PACKAGED DIMENSIONS	PACKAGED WEIGHT
85009	8' x 10'	12"L x 12"W x 12"H	26 lb.
29607	10' x 10'	20"L x 15.5"W x 9.5"H	33 lb.
85000	10' x 12'	16"L x 11"W x 14.5"H	39 lb.
29612	10' x 20'	20"L x 16"W x 13"H	65 lb.
29616	10' x 30'	17.5"L x 24"W x 14"H	98 lb.
85001	12' x 15'	18"L x 11.5"W x 14.5"H	59 lb.
85002	15' x 15'	20"L x 25.5"W x 15"H	74 lb.
85003	15' x 20'	19"L x 17"W x 19"H	98 lb.
85004	20' x 25'	21"L x 18"W x 22"H	164 lb.

\* Longer roll lengths of 150' and 200' available. Call for availability!

## LINER, UNDERLAYMENT, AND GEOTEXTILE

Underlayment is installed before the liner to prevent punctures from rough or rocky ground. Not only does underlayment provide protection for the liner, it also allows the ground to breathe from underneath. The fabric allows the earth's gases to escape from underneath the liner rather than becoming trapped, causing gas bubbles to push the liner up into the pond.

BOXED NON-WOVEN GEOTEXTILE UNDERLAYMENT			
ITEM NUMBER	UNDERLAYMENT DIMENSIONS	PACKAGED DIMENSIONS	PACKAGED WEIGHT
85010	10' x 15'	13"L x 12"W x 12"H	5.7 lb.

NON-WOVEN GEOTEXTILE UNDERLAYMENT ROLLS		
ITEM NUMBER	ROLL DIMENSIONS	PACKAGED WEIGHT
30300	5' x 300'	59 lb.
29169	15' x 300'	200 lb.
29170	7.5' x 600'	175 lb.
29227	Cut to Size	0.04 lb. per sq. ft. over 900 sq. ft.

## CONCRETE CLOTH™, ROCK PAD, AND WOVEN MICROGRID GEOTEXTILE



**Rock Pad**  
3' x 3'  
#25000

Packaged Weight: 1.1 lb.

The rock pad is an extra thick 3' x 3' non-woven polypropylene fabric that can be laid down on the liner before placing large rocks.

**Rock Pad**  
Roll—15' x 150'  
#25001

Packaged Weight: 260 lb.



**Woven Microgrid Geotextile**  
8' x 270'  
#42016

Packaged Weight: 65 lb.

The material provides a long-lasting barrier to prevent rock and debris from entering sub-surface water reservoirs while allowing water to easily infiltrate the storage basin.

**Woven Microgrid Geotextile**  
4' x 4'  
#42015

Packaged Weight: .5 lb.



**Concrete Cloth™ Roll**  
3.375' x 30'  
#85026

Packaged Weight: 141 lb.

- Flexible cement-impregnated fabric that hardens after hydration
- Acts as a protective barrier between liner and large rocks
- Protects liner from digging animals, vandalism, and more



## PIPE AND PLUMBING

**Complete your water feature with high quality plumbing products.** Whether you're starting a new project, or updating an existing water feature, you can trust Aquascape to provide what you need to get the job done right.

## PIPE AND PLUMBING



Flexible PVC pipe makes installations quick and easy. The main advantage of this high-quality pipe is that it has the durability to be glued into standard schedule 40 PVC fittings.

FLEXIBLE PVC PIPE		
ITEM NUMBER	PIPE DIMENSIONS	PACKAGED WEIGHT
29057	¾" x 25'	10 lb.
29058	¾" x 50'	14 lb.
48015	1" x 50'	14.5 lb.
29021	1½" x 25'	13 lb.
29022	1½" x 50'	24 lb.
29023	2" x 25'	14 lb.
29024	2" x 50'	30.75 lb.
29025	3" x 50'	57 lb.
29026	3" x 100'	118 lb.



Kink-free pipe is an excellent choice for quick and easy installations without the use of PVC cement. This high quality pipe is extremely flexible and resistant to crimping or collapsing around tight curves. Kink-free pipe works best when used with traditional stainless steel hose clamps and barbed fittings.

KINK-FREE PIPE		
ITEM NUMBER	PIPE DIMENSIONS	PACKAGED WEIGHT
98288	½" x 100'	9.25 lb.
94002	¾" x 25'	3.5 lb.
94003	¾" x 100'	17.75 lb.
94001	1" x 25'	4 lb.
94004	1" x 100'	16.75 lb.
94000	1¼" x 25'	6 lb.
94005	1¼" x 100'	23 lb.
94006	1½" x 25'	5.75 lb.
94007	1½" x 100'	38.5 lb.



Pre-cut kink-free pipe is ideal for fountain installations. The pieces are cut and packaged in convenient six-foot sections, ideal for installations requiring smaller lengths of pipe.

PRE-CUT KINK-FREE PIPE			
ITEM NUMBER	PIPE DIMENSIONS	PACKAGED DIMENSIONS	PACKAGED WEIGHT
88003	½" x 6'	10"L x 12"W x ¾"H	5 lb.
98404	¾" x 6'	14"L x 13"W x 1"H	1 lb.



Black vinyl tubing is ideal for recirculating water in fountains and other water features without the use of PVC glue. Our non-toxic, vinyl tubing is fish-safe, allowing for use in water features containing fish and plants.

BLACK VINYL TUBING		
ITEM NUMBER	PIPE DIMENSIONS	PACKAGED WEIGHT
94008	¾" x 100'	7 lb.
94009	½" x 100'	6 lb.
94010	¾" x 50'	11.75 lb.
94011	1" x 50'	12.25 lb.

## CHECK VALVES AND FLOW CONTROL VALVES

Plumbing materials provided by Aquascape include a complete selection of check valves, automatic water fill valves, and a variety of accessories, making it easy to complete any water feature with high quality plumbing products.



**Dual Union Check Valve 2.0**

**#48026**

Packaged Weight: 3.75 lb.

Packaged Dimensions: 14"L x 9"W x 4.75"H

The Dual Union Check Valve 2.0 provides a professional pump and plumbing connection inside skimmer filter systems, as well as Pondless® Waterfall Vaults. The innovative reversible fittings allow for universal application. The Dual Union Check Valve 2.0 prevents water backflow when the pump is not operating, while the dual-union, tool-free design makes maintenance quick and easy. The height is extendable for larger filters and pumps.



Designed for seamless integration in Aquascape skimmers and Pondless® Waterfall Vaults



**Fittings Included:**

- (2) Reversible 2" MPT x 2" Slip,
- (1) Reversible 1.5" FPT x 2" Slip

Reversible Fittings Eliminate Guesswork



**FEATURES OF THE DUAL UNION CHECK VALVE**

1. Angled, **swing-style valve** effectively prevents back flow
2. **Heavy-duty flapper** ensures longevity
3. **Dual-union connections** simplify pump and filter maintenance



**Dual Union 3" CVA Check Valve**

**#29098**

Packaged Weight: 7.5 lb.

Packaged Dimensions: 24"L x 9"W x 9"H

The Dual Union 3" CVA Check Valve is ideal for larger installations that use large pumps and filters. Heavy-duty, dual-union design ensures years of trouble-free use.



**2-Way Flow Control Valve**

**#88005**

Packaged Weight: 1.5 lb.

Packaged Dimensions: 9"L x 4.5"W x 8"H

Used to regulate water flow from one outlet to two independent water lines. Adjustable flow control valves make it easy to adjust the water flow between the two outlets.



**Check Valve Adapter for EcoWave® Pond Pump - 2"**

**#88058**

Packaged Weight: .5 lb.

Packaged Dimensions: 3.75"L x 3.75"W x 4"H

The Check Valve Adapter for EcoWave® Pond Pump - 2", is designed to make it quick and easy to connect Aquascape EcoWave pumps to the Dual Union Check Valve 2.0 (#48026).

**Note:** Compatible with EcoWave Pump models 2000-5000.

## WATER FILL VALVES

Aquascape water fill valves automatically add water to features when needed. They reduce the time-consuming maintenance of manually filling water features with a hose. Water fill valves also help protect the pump from running dry and eliminate large water chemistry swings (including chlorine/chloramine levels) that occur during manual top-offs.



**Compact Water Fill Valve**

**#88006**

Packaged Weight: .75 lb.

- Up to 1.5 gallons per minute flow rate at a working pressure of 0-100 PSI
- Small size allows it to fit into any skimmer filter, Pondless® Waterfall Vault, or decorative water feature application
- Includes fittings to connect to a standard garden hose, 1/4" poly-pipe, 1/2" poly-pipe, 1/2" pvc pipe (pipe sold separately)



**Water Fill Valve 200**

**#29272**

Packaged Weight: 1 lb.

- Up to 3 gallons per minute flow rate at a working pressure of 0-100 PSI
- Reliable mechanical arm-style fill valve
- Brass hardware with poly float
- Includes fittings to connect to 1/2" poly-pipe or 1/2" pvc pipe (pipe sold separately)



**Hudson Water Fill Valve**

**#29469**

Packaged Weight: 1.25 lb.

- Up to 1.5 gallons per minute flow rate at working pressure of 8-65 PSI
- Works great in Signature Series Pond Skimmers and Pondless® Waterfall Vault
- Mounting plate allows 4-inch setting adjustments
- Includes quick-connect fitting for 1/4" poly pipe
- Can also be used with 1/2" PVC by using the Fill Valve Irrigation Conversion Kit (Item #01008)

## WATER FILL VALVE ACCESSORIES



**Fill Valve Spigot 1/4" Quick-Connect**

**#07000**

Packaged Weight: .25 lb.

Connects 1/4" poly pipe to garden spigot.



**Garden Hose Adapter Assembly**

**#29517**

Packaged Weight: .25 lb.

Connects 1/2" poly pipe to garden spigot.



**Fill Valve Irrigation Conversion Kit**

**#01008**

Packaged Weight: .05 lb.

Converts the 1/4" Hudson Water Fill Valve up to 1/2" poly pipe or PVC.



**WFV Poly Pipe Roll**

1/4" x 100'

**#29350**

Packaged Weight: 1.25 lb.



**WFV Poly Pipe Roll**

1/2" x 100'

**#29470**

Packaged Weight: 5 lb.



**Whether you are a do-it-yourselfer or professional water feature contractor,** Aquascape has all the pieces and parts you need for successful water feature installation or repair. Installation tools, spare parts, and accessories are available individually or as part of a kit.

INSTALLATION TOOLS



**Pond and Waterfall Foam Sealant**

**#82002**

Packaged Weight: 1 lb.

No gun applicator needed! Easy to use for the beginner or do-it-yourselfer. Convenient and economical for a small project or the quick touch-up on a larger project. Also sold as part of our Installation Kit (#22008).



**Professional Black Waterfall Foam**

**#30096**

Packaged Weight: 2 lb.

24 oz. can of expandable Professional Black Waterfall Foam. Equivalent to Pond and Waterfall Foam Sealant. To be used with foam guns (sold separately).



**Professional Foam Gun Cleaner**

**#22011**

Packaged Weight: 1.25 lb.

A handy cleaner to flush the foam gun clean if it is not working properly. It will also remove uncured foam.



**Economy Foam Gun Applicator**

**#54003**

Packaged Weight: 1.5 lb.

This lower-priced foam gun provides an attractive price point so that all contractors, no matter how many features they build, can afford to add a foam gun to their pond-building tool kit. To be used with Professional Black Waterfall Foam.



**Professional Foam Gun Applicator**

**#29268**

Packaged Weight: 1.25 lb.

Aquascape Professional Foam Gun Applicator is designed to create an air and moisture-tight seal between the gun and the can, allowing for maximum foam yield and minimal waste. To be used with Professional Black Waterfall Foam.



**Professional Foam Gun Kit**

**#22013**

Packaged Weight: 13.5 lb.

**Kit includes:**

- Case
- (3) Professional Black Waterfall Foam
- Professional Foam Gun Applicator
- Professional Foam Gun Cleaner



**Black Silicone Sealant**

4.7 oz.

**#22010**

Packaged Weight: .5 lb.

- Used for sealing joints where liner attaches to BioFalls® lip and the skimmer faceplate
- Fish-safe



**Black Silicone Sealant**

10.1 oz.

**#29186**

Packaged Weight: .5 lb.

- Used for sealing joints where liner attaches to BioFalls® lip and the skimmer faceplate
- Fish-safe



**Clear Silicone Sealant**

10.1 oz.

**#82000**

Packaged Weight: .75 lb.

- Used for sealing joints where liner attaches to BioFalls® lip and the skimmer faceplate
- Fish-safe



INSTALLATION TOOLS



**Installation Kit**  
#22008

Packaged Weight: 2.25 lb.

**Kit includes:**

- Liner Patch
- Christy's Red Hot Blue Glue
- Black Silicone Sealant
- Pond and Waterfall Foam Sealant



**Firestone® QuickSeam Pond Liner Repair Kit**  
#42023

Packaged Weight: .5 lb.

**Kit includes:**

- 6" x 6" QuickSeam patches
- Bottle of LVOC Primer (2 oz. / 57 ml)
- Scrubber pad
- Patch roller
- Pair of disposable gloves



**EPDM Liner Patch 6"**  
#22018

Packaged Weight: .25 lb.

This 6" self-adhesive patch quickly repairs holes, tears, and cuts in liner.



**Christy's Red Hot Blue Glue**  
4 oz.  
#29969

Packaged Weight: .4 lb.

The original all-weather, wet or dry PVC cement.



**Cleanout Pump**  
#45033

Packaged Weight: 26.5 lb.

- Great for pond cleanouts and installation wash-downs
- 4,200 GPH for fast pump-outs
- Pumps water down to 1/4" off the bottom



**Firestone® QuickScrubber Kit**  
#54009

Packaged Weight: .75 lb.

**Kit includes:**

- 30 scrub pads
- 4 holders designed for the application of Firestone® QuickPrime Plus—EPDM Liner Seaming Tape Primer.



**EPDM Liner One-Sided Cover Tape**  
6" x 25'  
#22003

Packaged Weight: 6.25 lb.



**Cleanout Pump Discharge Hose 50'**  
#48019

Packaged Weight: 14.75 lb.

- Heavy-duty cleanout discharge hose engineered for flexibility and optimal flow
- Swivel cuff fitting prevents kinking or tangling, allowing easy movement around the water feature



**Firestone® QuickPrime Plus—EPDM Liner Seaming Tape Primer**  
1 qt. / 0.95 L  
#54008

Packaged Weight: 2 lb.

Firestone® QuickPrime Plus is designed to clean and prime EPDM liner prior to seaming.



**EPDM Liner One-Sided Cover Tape**  
6" x 100'  
#22005

Packaged Weight: 20 lb.



**EPDM Liner Double-Sided Seam Tape**  
3" x 25'  
#22017

Packaged Weight: 2 lb.



**EPDM Liner Double-Sided Seam Tape**  
3" x 100'  
#22020

Packaged Weight: 20 lb.



**The Aquascape Rainwater Harvesting System** adds the beauty of a water feature to a rainwater collection system for capturing, filtering, and reusing our most precious resource – water! Whether you choose a Pondless® Waterfall or bubbling urn to add to your landscape, you'll be happy knowing your rainwater harvesting system not only looks great but is beneficial for the environment too.

AQUASCAPE RAINWATER HARVESTING SYSTEM COMPONENTS

PONDLESS® WATERFALL

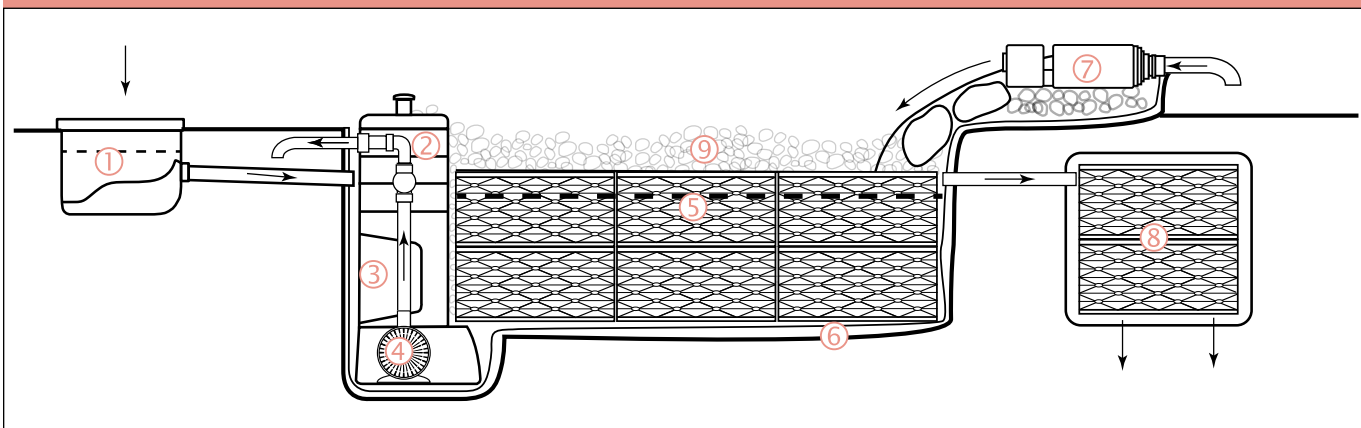

- |   |                                    |                       |
|---|------------------------------------|-----------------------|
| 1. Downspout Filter                     | 4. Pump                            | 7. Waterfall Spillway |
| 2. Pondless® Waterfall Vault Extensions | 5. AquaBlox® Water Storage Modules | 8. Overflow Drainage  |
| 3. Pondless® Waterfall Vault            | 6. Liner and Underlayment          | 9. Rocks and Gravel   |

FOUNTAIN

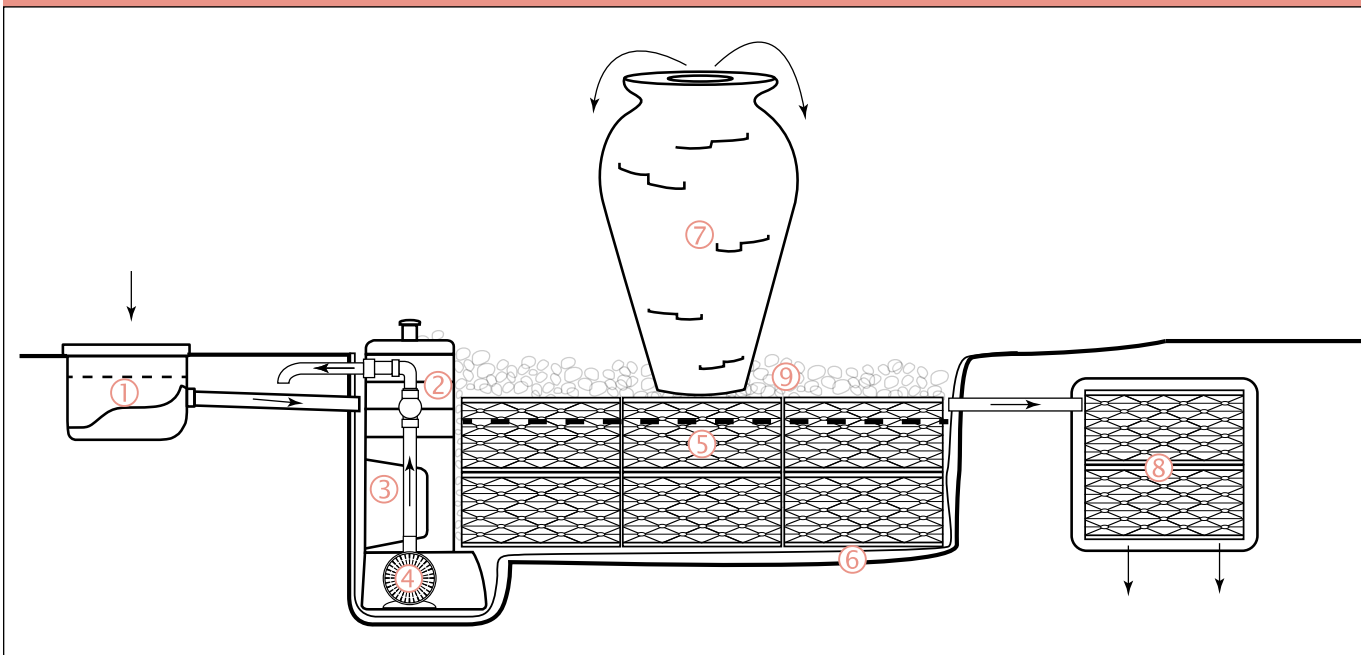

- |   |                                    |                        |
|---|------------------------------------|------------------------|
| 1. Downspout Filter                     | 4. Pump                            | 7. Decorative Fountain |
| 2. Pondless® Waterfall Vault Extensions | 5. AquaBlox® Water Storage Modules | 8. Overflow Drainage   |
| 3. Pondless® Waterfall Vault            | 6. Liner and Underlayment          | 9. Rocks and Gravel    |

## STEP 1: CHOOSE THE WATER STORAGE SYSTEM

Each Aquascape Rainwater Harvesting System Water Storage Kit Includes: Pondless® Waterfall Vault Extension(s), AquaBlox®, 45 mil EPDM Liner, and two pieces of non-woven geotextile underlayment (one to surround the AquaBlox and one to surround the exterior of the EPDM liner).



### 500 Gallon Water Storage Kit

#30097

**Kit Includes:**

- Basin Size: 6' x 9' x 4'
- (16) AquaBlox Large Water Storage Modules
- 45 mil EPDM Liner—15' x 20'
- (2) Underlayment—300 sq. ft.
- Pondless® Waterfall Vault Extension

### 1000 Gallon Water Storage Kit

#30099

**Kit Includes:**

- Basin Size: 6' x 9' x 5'
- (32) AquaBlox Large Water Storage Modules
- 45 mil EPDM Liner—20' x 25'
- (2) Underlayment—500 sq. ft.
- (4) Pondless® Waterfall Vault Extensions

### 1500 Gallon Water Storage Kit

#30102

**Kit Includes:**

- Basin Size: 8' x 9' x 5'
- (48) AquaBlox Large Water Storage Modules
- 45 mil EPDM Liner—25' x 25'
- (2) Underlayment—625 sq. ft.
- (4) Pondless® Waterfall Vault Extensions

### 2000 Gallon Water Storage Kit

#30105

**Kit Includes:**

- Basin Size: 9' x 11' x 5'
- (64) AquaBlox Large Water Storage Modules
- 45 mil EPDM Liner—25' x 30'
- (2) Underlayment—750 sq. ft.
- (4) Pondless® Waterfall Vault Extensions

### 2500 Gallon Water Storage Kit

#30108

**Kit Includes:**

- Basin Size: 11' x 12' x 5'
- (80) AquaBlox Large Water Storage Modules
- 45 mil EPDM Liner—25' x 30'
- (2) Underlayment—750 sq. ft.
- (4) Pondless® Waterfall Vault Extensions

### 3000 Gallon Water Storage Kit

#30112

**Kit Includes:**

- Basin Size: 9' x 11' x 6'
- (96) AquaBlox Large Water Storage Modules
- 45 mil EPDM Liner—25' x 30'
- (2) Underlayment—750 sq. ft.
- (6) Pondless® Waterfall Vault Extensions

STEP 2: CHOOSE THE WATER FEATURE



Rainwater Harvesting Fountain Add-On Kit

#44000

Kit Includes:

- Pondless® Waterfall Vault
- Downspout Filter
- AquaSurge® 2000-4000 Adjustable Flow Pond Pump
- Kink-Free Pipe—¾" x 25'
- Overflow Kit
- Decorative Fountain Component Bag

Select from a number of decorative bubbling urns and stone fountains (seen on pages 121-127) that sit on top of the Aquascape Rainwater Harvesting System reservoir. The water spills over the top of the decorative piece and flows back down into the sub-surface reservoir where it is re-circulated by the pump.



Rainwater Harvesting Pondless® Waterfall Add-On Kit

#44001

Kit Includes:

- Pondless® Waterfall Vault
- Waterfall Spillway
- Downspout Filter
- AquaSurge® 2000-4000 Adjustable Flow Pond Pump
- LED Lighting Package
- Flexible PVC Pipe—2" x 25'
- 45 mil EPDM Liner—10' x 20'
- Overflow Kit
- Installation Kit

Use this kit to create a beautiful waterfall or stream. Rainwater stored in the sub-surface reservoir is pumped to the top of the waterfall where it flows out and over the rocks creating melodic sounds. The water returns to the reservoir that's covered with decorative stone and is continually re-circulated up and over the waterfall.



Rainwater Harvesting Downspout Filter

#30166

The Downspout Filter is installed at the base of the downspout ready to capture rainwater and remove a variety of debris that may be flushed into the system during a rain event. Incoming rainwater is passed through a series of mechanical filters that remove leaves, twigs, seeds, and small sediment that accumulate on the surface of the roof between rain events.

- Utilize our online Rainwater Harvesting Calculator to determine how many Downspout Filters your project will require.
- Add a Downspout Filter onto a water feature and use rainwater to top off the water level.
- Handles up to a 1,500 sq. ft. roof and more than 50 gallons per minute flow rate.
- Add a Downspout Filter to any fountain or Pondless® Waterfall feature and make it sustainable!

STEP 3: CHOOSE THE DECORATIVE FOUNTAIN



Small Stacked Slate Sphere

#78287

For more information, see page 125.



Medium Scalloped Urn

#78239

For more information, see page 123.



Natural Mongolian Basalt Columns Set of 3

#58062

For more information, see page 122.

Small Stacked Slate Urn

#98939

For more information, see page 124.

Medium Rippled Urn

#78242

For more information, see page 123.

Natural Mongolian Basalt Column 30"

#98503

For more information, see page 122.

For more fountain options, see page 121-127.

# Index

## A

Activated Pond Carbon **91**  
Adjustable Flow Pump Extension Cord **7, 44, 52**  
Adjustable Pouring Bamboo Fountain **132**  
Aeration Compressor Manifold **63**  
Algaecide **92**  
Alkalinity Booster **91**  
Alligator Spitter **132**  
Ammonia Neutralizer **91**  
Ammonia Neutralizer Professional Grade **97**  
AquaBasin® 30 **120, 122**  
AquaBasin® 45 **19, 21, 22, 23, 24, 44, 51, 120, 122**  
AquaBlox® Large Water Storage Module **16, 17, 38**  
AquaBlox® Small Water Storage Module **15, 16, 17, 38**  
AquaForce® Solids-Handling Pond Pumps **52**  
AquaForce® Adjustable Flow Solids-Handling Pond Pumps **52**  
AquaGarden Mini Pond Kits **130**  
AquaGarden Plant Light **130**  
AquaGarden Stand **130**  
AquaGarden Tabletop Fountain Kits **7, 131**  
AquaJet® Pond Pumps **54**  
Aquamarine Fire Glass **119**  
AquaSurge® Pond Pumps **7, 10, 12, 15, 16, 17, 19, 30, 43, 44, 45, 149**  
AquaSurge® Adjustable Flow Pond Pumps **44**  
Aquatic Lily Planter **113**  
Aquatic Patio Pond Kit **129**  
Aquatic Planters **113**  
Auto-Ignite Fire Features **115, 116**  
Automatic Dosing System for Fountains **15, 16, 17, 82**  
Automatic Dosing System for Ponds **10, 12, 82**  
Automatic Dosing System (G1) Treatments **83, 84, 85, 86, 87**

## B

Backyard Waterfall Landscape Fountain Kit **18, 19, 128**  
Bacteria Bubble Tabs **89**  
Bamboo Fountains **132**  
Barbed Coupling **63**  
Barley Straw Extract **93**  
Barley Straw Extract Professional Grade **97**  
Beneficial Bacteria **88**  
Beneficial Bacteria Concentrate **88**  
Beneficial Bacteria Concentrate Professional Grade **96**  
Beneficial Bacteria Professional Grade **96**  
BioBalls Biological Filter Media **32**  
BioBalls Filter Media Net **32**  
BioFalls® Filters **28, 29**  
Black Pond Dye **94**  
Black Silicone Sealant **10, 11, 12, 15, 16, 17, 19, 144, 145**  
Black Vinyl Tubing **140**  
Blue Heron Decoy **101**  
Blue Pond Dye **94**

## C

Boxed Non-Woven Geotextile Underlayment **138**  
Bulk Protective Pond Netting **105**  
Check Valve Adapter for EcoWave® Pond Pump **51, 141**  
Check Valves **141**  
Christy's Red Hot Blue Glue **145**  
Clean for Fountains **79, 83, 85, 87**  
Clean for Ponds **79, 82, 83, 85, 86**  
Cleanout Pump **59, 145**  
Cleanout Pump Discharge Hose **59, 145**  
Clear for Fountains **83**  
Clear for Ponds **79, 82, 83, 85, 86**  
Clear Silicone Sealant **144**  
Coarse Filter Media Roll **32**  
Cold Water Beneficial Bacteria **88, 104**  
Cold Water Beneficial Bacteria Professional Grade **96**  
Color-Changing Fountain Light **68**  
Color-Changing Fountain Light Kit **68**  
Color-Changing Light Extension Cable **69**  
Color-Changing Light Remote **66**  
Color-Changing Lights **66, 67**  
Color-Changing Light Splitter **69**  
Color-Changing Spotlight **67**  
Compact Water Fill Valve **142**  
Concentrated Barley Straw Pellets **94**  
Concrete Cloth™ Roll **138**  
Container Water Garden Filter **31**  
Copper Test Kit **41**  
Crane with Lowered Head Spitter **133**  
Crazy Legs Frog Spitter **133**  
Curved Stacked Slate Wall Bases **126**  
Curved Stacked Slate Wall Toppers **126**

## D

DecoBasin **120, 124**  
Decorative Accessories **134, 135**  
Decorative River Pebbles **134**  
Decorative Spitters **132, 133**  
Deer Scarer Bamboo Fountain **132**  
Deluxe Pond Kits **12**  
Deluxe Pondless® Waterfall Kits **17**  
Dense Filter Media Roll **32**  
DIY Backyard Pond Kits **10**  
DIY Backyard Waterfall Kit **15**  
Dome Top Path and Area Landscape Light **73**  
Dome Top Path and Area Landscape Light 6-Pack **73**  
Double Frog with Cattail Spitter **132**  
Double-Textured Basalt Columns Set of 3 **122**  
Dragonfly Spitter **132**  
Dual Union 3" CVA Check Valve **141**  
Dual Union Check Valve 2.0 **10, 11, 12, 15, 16, 17, 51, 141**

## E

EcoBlast™ Contact Granular Algaecide **92**  
Economy Foam Gun Applicator **144**  
EcoWave® 2000 Pond Pump **10, 15, 50**  
EcoWave® Pond Pumps **50, 51, 141**  
EcoWave® Pond Pump Attachments **51**  
EPDM Boxed Liner **137**  
EPDM Liner **10, 11, 12, 15, 16, 17, 19, 137, 145, 148, 149**  
EPDM Liner Double-Sided Seam Tape **145**  
EPDM Liner One-Sided Cover Tape **145**

EPDM Liner Patch **10, 11, 12, 15, 16, 17, 145**  
EPDM Liner Rolls **137**  
EXT Pond Pumps **7, 49**  
EXT Pump Plumbing Kit **49**

## F

Faux Driftwood **12, 17, 134**  
Faux Log Fish Cave **101, 135**  
Faux Oak Stump Cover **135**  
Faux Stone Fire Pit **116**  
Faux Stone Propane Tank Cover **117, 118**  
Faux Stump Propane Tank Cover **7, 118**  
Fill Valve Irrigation Conversion Kit **142**  
Fill Valve Spigot 1/4" Quick-Connect **142**  
Filter Rolls and Mats **32**  
Fire and Water 3-Piece Basalt Torch System **117**  
Fire and Water Basalt Column Torch **117**  
Fire and Water Spillway Bowl **116**  
Fire and Water Stacked Slate Sphere - Medium **116**  
Fire and Water Stacked Slate Urn - Large **7, 116**  
Fire Fountain **119**  
Fire Fountain Add-On Kit **123, 124, 125**  
Fire Media **119**  
Firestone® QuickPrime Plus—EPDM Liner Seaming Tape Primer **145**  
Firestone® QuickScrubber Kit **145**  
Firestone® QuickSeam Pond Liner Repair Kit **145**  
Fish Food **108, 109**  
Fish Treatments **110**  
Flexible PVC Pipe **140**  
Floating Alligator Decoy **101**  
Floating Plant Island **113**  
Floating Swan Decoy **101**  
Flow Control Valve **33, 35, 141**  
Fountain Foam Free **95**  
Fountain Light **72**  
Fountain Light Kit with Transformer **72**  
Fountain Maintenance **95**  
Fountain Scale Free **95**  
Fountain Shims **134**  
Frog on Reed Spitter **133**  
Front-Spill Curved Stacked Slate Topper **126**  
Front-Spill Straight Stacked Slate Topper **127**  
Fungus Treatment **110**

## G

Garden Hose Adapter Assembly **142**  
Geotextile **136, 138**

## H

Hat Top Path and Area Landscape Light **73**  
Hat Top Path and Area Landscape Light 6-Pack **73**  
Heavy Duty Pond Net with Extendable Handle **111**  
Heavy Duty Pond Skimmer Net with Extendable Handle **111**  
High Density Rigid Filter Mat **32**  
Hudson Water Fill Valve **142**

## I

Installation Kit **10, 11, 12, 144, 145, 149**  
IonGen™ G2 Probe Holder **41**

IonGen™ Probe for the G2 System **41**  
IonGen™ System G2 **40**

## K

Keyed Basalt Columns Set of 3 **122**  
KH/Alkalinity Test Kit **41**  
Kid's Pond Explorer Net **111**  
Kink-Free Pipe **140**  
Koi Krunchies **109**  
Koi Sock Net **111**

## L

Lake Bacteria **96**  
Lake Bacteria Packs **98**  
Lake Blue Dye Packs **99**  
Lake Flocculant Clarifier **99**  
Lake Phosphate Binder Packs **99**  
Lake Sludge Remover Packs **98**  
Lake Treatment Booster Packs **99**  
Landscape Fountain Kits **22, 23, 24**  
Large Centipede® Module **39**  
Large Curved Stacked Slate Wall Base **126**  
Large Deluxe Pond Kit 21' x 26' **12**  
Large Deluxe Pondless® Waterfall Kit 26' Stream **17**  
Large Pond Filter Urn **30**  
Large Pond Kit 21' x 26' **11**  
Large Pondless® Waterfall Kit 26' Stream **16**  
Large Rippled Urn **123**  
Large Scalloped Urn **123**  
Large Snorkel® Vault and Cap **39**  
Large Snorkel® Vault Extension **39**  
Large Stacked Slate Sphere **125**  
Large Stacked Slate Urn **124**  
Large Straight Stacked Slate Wall Base **127**  
Large Ultra Pump Fountain Head Kit **57**  
Lazy Frog on Lily Pad Spitter **133**  
Liner **9, 14, 18, 38, 39, 136, 137, 138, 144, 145, 148**  
Low Density Rigid Filter Mat 1.5" Thick **32**  
Low Suction Intake Attachment **19, 44, 51**  
Low Voltage Accessories **74**  
Low Voltage Quick-Connect Transformer **76**  
Low Voltage Transformer with Photocell **76**

## M

Maintain for Ponds **10, 11, 12, 79, 82, 83, 84, 85, 86**  
Man in Barrel Spitter **133**  
Match-Lit Flame Control System **117**  
Medium Deluxe Pond Kit 11' x 16' **12**  
Medium Deluxe Pondless® Waterfall Kit 16' Stream **17**  
Medium Density Rigid Filter Mat 1.5" Thick **32**  
Medium Pond Kit 11' x 16' **11**  
Medium Pondless® Waterfall Kit 16' Stream **16**  
Medium Rippled Urn **22, 123, 149**  
Medium Rippled Urn Landscape Fountain Kit **22, 123**  
Medium Scalloped Urn **22, 123, 149**  
Medium Scalloped Urn Landscape Fountain Kit **22**  
Medium Stacked Slate Sphere **22, 125**  
Medium Stacked Slate Sphere Landscape Fountain Kit **22, 125**

Medium Stacked Slate Urn **22, 124**  
Medium Stacked Slate Urn  
Landscape Fountain Kit **22, 124**  
Mongolian Basalt Column 30"  
Landscape Fountain Kit **24, 122**  
Mongolian Basalt Columns Set of 3  
Landscape Fountain Kit **24, 122**  
Multi-Purpose Nets **111**

## N

Natural Mongolian Basalt Column  
**122, 149**  
Natural Mongolian Basalt Columns  
Set of 3 **122, 149**  
Naughty Dog Spitter **133**  
Nets **111**  
Non-Woven Geotextile Underlayment  
Rolls **138**

## P

Parasite & Ich Treatment **110**  
Path and Area LED Landscape Lights **73**  
Patio Ponds **129**  
Patio Pond Maintenance Tabs **95**  
Pipe **23, 24, 30, 31, 41, 55, 56, 140, 142**  
PL Solids-Handling Pond Pumps **48**  
PN Solids-Handling Pond Pumps **48**  
Pond Aeration Kits **61, 62, 104**  
Pond Aerator Aeration Disc **61**  
Pond Aerator Pro Check Valve **63**  
Pond and Waterfall Foam Sealant **10, 11, 12, 15, 16, 17, 19, 24, 144, 145**  
Pond & Debris Clarifier Professional  
Grade **96**  
Pond Debris Skimmer Nets **111**  
Pond De-Icer **104, 105**  
Pond Detoxifier Professional Grade **97**  
Pond Detoxifier **91, 104**  
Pond Filter Urn **30**  
Pond Foam Free **91**  
Pondless® Waterfall Vault **14, 15, 16, 17, 37, 41, 48, 50, 142, 147, 148, 149**  
Pondless® Waterfall Vault Extension  
**37, 148**  
Pond Nets **111**  
Pond Net with Extendable Handle **111**  
Pond Plant Potting Media **113**  
Pond Powerhead **12, 55, 104**  
Pond Salt **110**  
Pond Shark **111**  
Pond Shark Pro **111**  
Pond Skimmer Filters **26, 27**  
Pond Skimmer Net with Extendable  
Handle **111**  
Pond Sludge Remover Packs **90**  
Pond Starter Bacteria **89, 104**  
Pond Starter Bacteria Professional  
Grade **96**  
Pond Thermometers **103**  
Pond Waterfall Filter **30**  
Pouring 3-Tier Bamboo Fountain **132**  
Praziquantel Treatment **110**  
Pre-Cut Kink Free Pipe **140**  
Premium Cold Water Fish Food Pellets  
**104, 108**  
Premium Color Enhancing Fish Food  
Pellets **108**  
Premium Fish Food Flakes **109**  
Premium Staple Fish Food Pellets  
**104, 108**

Prevent for Fountains **15, 16, 17, 79, 83, 84, 85, 87**  
Pro Air 20 Aeration Compressor **63**  
Pro Air 20 Pond Aeration Kit **62**  
Pro Air 60 Aeration Compressor **63**  
Pro Air 60 Pond Aeration Kit **62**  
Pro Air Pond Aeration Accessories **63**  
Professional Black Waterfall Foam **144**  
Professional Fish Net with Extendable  
Handle **111**  
Professional Foam Gun Applicator **144**  
Professional Foam Gun Cleaner **144**  
Professional Foam Gun Kit **144**  
Professional Grade Pond Kits **10, 11**  
Professional Grade Pond Net **111**  
Professional Grade Pond Skimmer  
Net **111**  
Professional Pondless® Waterfall Kits  
**15, 16**  
Propane Tank Covers **7, 117, 118**  
Propane Tank Regulator and Hose **117**  
Protect for Ponds **79, 82, 83, 85, 86**  
Protective Pond Netting **104, 105**  
Pump Cleaner Maintenance Solution **59**

## Q

Quad-Spill Curved Stacked Slate  
Topper **126**  
Quad-Spill Straight Stacked Slate  
Topper **127**  
Quick-Connect Extension Cable **11, 16, 74**  
Quick-Connect Photocell with Timer **74**  
Quick-Connect Splitter **11, 16, 55, 74**  
QuickFix Pond Gummy **94**

## R

Rainwater Harvesting Downspout  
Filter **149**  
Rainwater Harvesting Fountain Add-  
On Kit **149**  
Rainwater Harvesting Pondless®  
Waterfall Add-On Kit **149**  
Rainwater Harvesting System **146, 147, 148, 149**  
Rapid Clear Fine Filter Pads **93**  
Rapid Clear Flocculant **93, 96**  
Rapid Clear Flocculant Professional  
Grade **96**  
Rear-Spill Curved Stacked Slate  
Topper **126**  
Reflective Black Fire Glass **119**  
Reflective Cobalt Blue Fire Glass **119**  
Reinforced Polypropylene Liner **137**  
Rippled Urn **22, 123, 149**  
Rock & Fountain Cleaner **95**  
Rock Pad **136, 138**  
Round Propane Tank Cover - Gray  
**7, 118**  
Rubber Gas Hose **117**  
Rubber Membrane Aeration Diffuser **63**

## S

SAB Stream & Pond Cleaner **93**  
SAB Stream & Pond Cleaner  
Professional Grade **97**  
Scalloped Urn **22, 123, 149**  
Semi-Polished Stone Basalt Columns  
Set of 3 **122**  
Signature Series Pond Skimmers **26**  
Signature Series 1000 BioFalls® Filter  
**10, 28**

Signature Series 2500 BioFalls® Filter  
**11, 12, 28**  
Signature Series 6000 BioFalls® Filter  
with 2" Bulkhead **28**  
Signature Series 6000 BioFalls® Filter  
with 3" Bulkhead **28**  
Simple Solutions 3X Treatments **83, 84, 85, 86**  
Simple Solutions Pump Tops For  
Fountains **87**  
Simple Solutions Pump Tops For  
Ponds **83, 84, 85, 86**  
Simple Solutions Treatments for XT  
Dosing System **7, 83, 84, 85, 86, 87**  
Simple Solutions Water Treatments **79, 83, 84, 85, 86, 87**  
SLD 2000-5000 Adjustable Flow  
Pond Pump **46**  
SLD 4000-7000 Adjustable Flow  
Pond Pump **16, 46**  
SLD 5000-9000 Adjustable Flow  
Pond Pump **16, 46**  
SLD Adjustable Flow Pond Pumps  
**46, 47**  
Sludge & Filter Cleaner **90**  
Sludge & Filter Cleaner Professional  
Grade **97**  
Small Curved Stacked Slate Wall  
Base **126**  
Small Pond Filter Urn **30**  
Small Pond Kit 8' x 11' **10**  
Small Pondless® Waterfall Kit 6'  
Stream **15**  
Small Rippled Urn **123**  
Small Scalloped Urn **123**  
Small Stacked Slate Sphere **125, 149**  
Small Stacked Slate Urn **124, 149**  
Small Straight Stacked Slate Wall  
Base **127**  
Small Ultra Pump Fountain Head Kit **57**  
Smart Control Hub **6, 12, 17, 64, 66, 67, 68**  
Smart Control Plug **6, 75, 77, 135**  
Smart Control Receiver **6, 7, 43, 44, 46, 47, 52**  
Smart Pond Dosing System Controller  
Add-On Kit **80**  
Smart Pond Dosing System XT **6, 7, 79, 80, 81**  
Smart Pond Dosing System Pump  
Cartridge **80**  
Smart Pond Thermometer **6, 103, 104**  
Smart Pond Thermometer with  
Transformer **103**  
Spillway Basin **121**  
Spillway Bowl **23, 116, 121**  
Spillway Bowl and Basin Landscape  
Fountain Kit **23**  
Spillway Bowl Stand **121**  
Splitter with Caps **117**  
Spotlight **11, 12, 67, 70, 71**  
Spotlight 6-Pack **71**  
Spotlight Kit **70**  
Square Propane Tank Cover -  
Travertine **7, 118**  
Stacked Slate Spillway Wall 32"  
Landscape Fountain Kit **23, 127**  
Stacked Slate Topper **126, 127**  
Stacked Slate Wall Base **126, 127**

Stainless Steel Fire Pan Cover **7, 118**  
Standing Crane Spitter **133**  
Statuary Water Pump **58**  
Stone Basalt Columns **122**  
Straight Stacked Slate Wall Bases **127**  
Straight Stacked Slate Wall Toppers **127**  
Submersible Pond Filter **31**  
Submersible Pond Thermometer **103**

## T

Toucan Spitter **133**  
Transformers **76**  
Tumbled Lava Stones **118, 119, 134**

## U

Ulcer & Bacterial Treatment **110**  
Ultra Water Pumps **7, 56**  
UltraKlean™ Pond Filters **34**  
UltraKlean™ Pond Filtration Kits **35**  
UltraKlear® UV Clarifier **33**  
Underlayment **9, 10, 11, 12, 14, 15, 16, 17, 19, 136, 138, 147, 148**  
Universal Remote for Adjustable Flow  
Pumps **44, 52**  
U-Shaped Ground Stakes **105**

## W

Warm White Fountain Lights **72**  
Warm White Led Lights **71**  
Waterfall Light **11, 12, 16, 17, 67, 71**  
Waterfall Light 6-Pack **71**  
Waterfall & Rock Cleaner Professional  
Grade **97**  
Waterfall Spillway 12" **19, 36**  
Waterfall Spillway 22" **15, 16, 17, 36**  
Water Feature Basins **120**  
Water Fill Valve Accessories **142**  
Water Fill Valves **142**  
Water Pump **31, 56, 57, 58, 116, 117, 121, 122, 123, 124, 125, 126, 127, 132, 133**  
Water Storage Kit **148**  
Weighted Aeration Tubing **63**  
Wetland Pond & Lake Bacteria  
Professional Grade **96**  
WVF Poly Pipe Roll **142**  
Woven Microgrid Geotextile **136, 138**



Prsrt Std  
U.S. Postage  
**PAID**  
Aquascape  
Designs, Inc.

901 Aqualand Way • St. Charles, IL 60174  
Toll Free: (866) US-PONDS or (866) 877-6637  
Customer Service Fax: (630) 659-2100  
Technical Support Fax: (877) 329-2348  
support.aquascapeinc.com

2022 Aquascape, Inc.  
All Worldwide Rights Reserved.



**Shop on Our Website**  
aquascapeinc.com



**Follow Us on Facebook**  
facebook.com/aquascapeinc



**Follow Us on Instagram**  
instagram.com/aquascape\_inc



**Get Inspired on Pinterest**  
pinterest.com/aquascapeinc



**Pondside Monthly E-Newsletter**  
aquascapeinc.com/pondside-monthly-e-newsletter



**Watch Us on YouTube**  
youtube.com/aquascape4



**Aquascape Lifestyles E-Magazine**  
aquascapeinc.com/aquascape-lifestyles-magazine



**Greg Wittstock, The Pond Guy**  
youtube.com/gregwittstockthepondguy



**TEAM Aquascape**  
youtube.com/TEAMaquascape



**Ed The Pond Professor**  
youtube.com/edthepondprofessor